

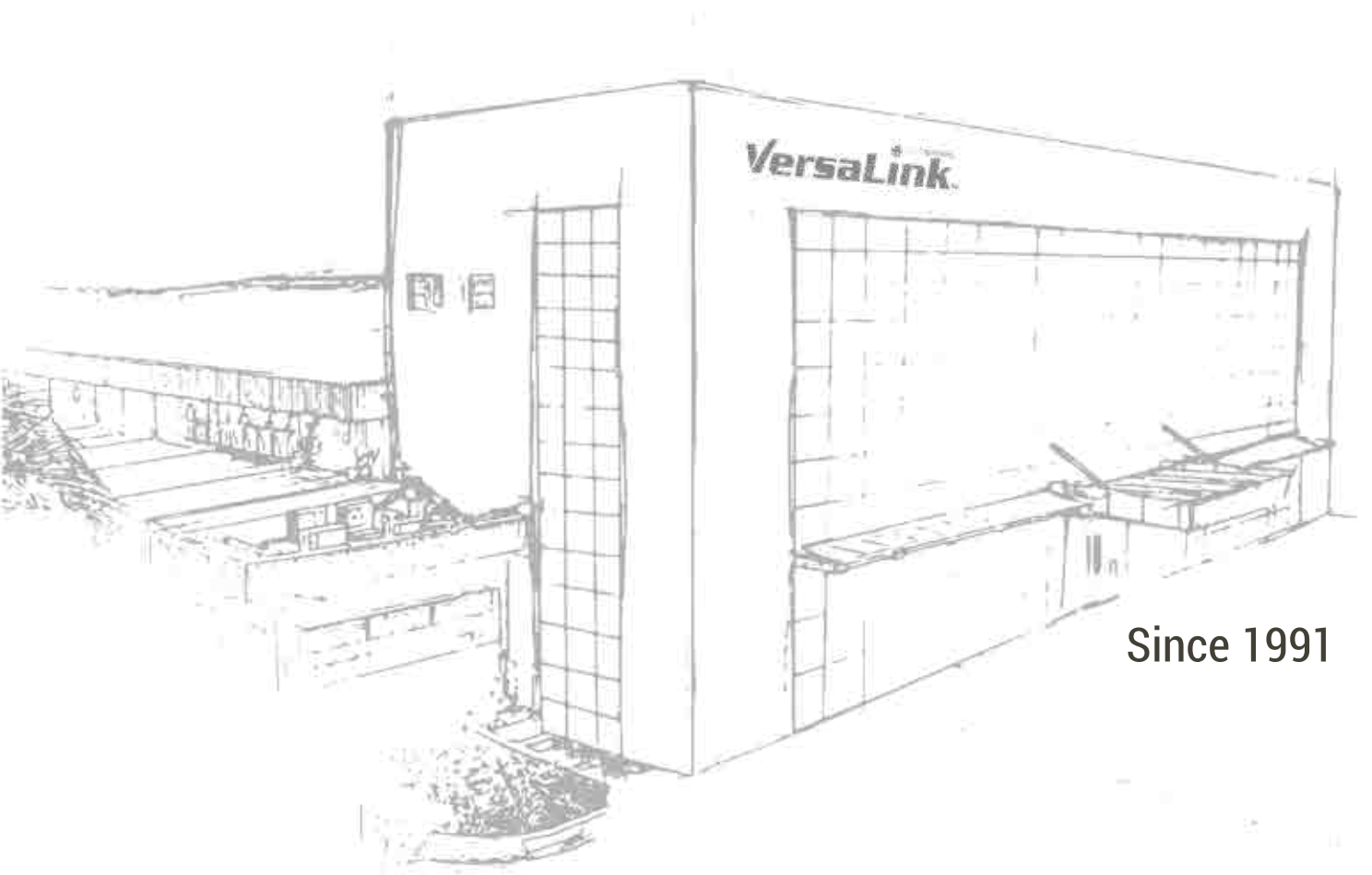

*MODERN EMIRATES
FURNITURES &
OFFICE EQUIPMENTS
(L.L.C)*

GENERAL CATALOGUE

OUR COMPANY



Since 1991



Leading Office Furniture Manufacturer

i n M a l a y s i a

VERSALINK is a leading office furniture manufacturer and designer based in the town of Klang, Malaysia. With more than 30 year of experience with our in-house designers, consultants and manufacturing capabilities, our products are exported worldwide to North America, Australia, Middle East and throughout Asia.



CURRENT PLANT
176,000 Sq Ft



WORKFORCE
>300 EMPLOYEES



INVENTORY STOCK
Raw material of
18000pcs for quick
production



EDGING COLOUR
9 Different Sizes,
104 Colours
14000 m2 of Stock

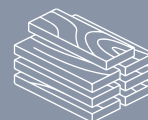

MATERIAL
14 Standard
Material Colours



WAREHOUSE
45,000 Sq Ft



intertek



The mark of
responsible forestry



OUR COMPANY

PRODUCT INDEX



ACOUSTICS

ACOUSTIC POD

- Tele-Pod 2.0
- Sharing- Pod 2.0
- Office Pod

ACOUSTIC ROOM COLLECTION

- Focus Quiet Room



ARCHITECTURAL & SPACE DIVISION

ARCHITECTURAL Fonte I



EXECUTIVE SERIES

SENIOR EXECUTIVE

- SE-Evoke
- SE-Fame
- SE-Lush
- SE-Presta
- SE-Royalta
- SE-Empower
- SE-Supra
- SE-Inspira
- SE-Legato 2.0
- SE-Verve 2.0
- SE-Houston
- SE-President

EXECUTIVE

- E-Pragmo
- E-Utilia
- E-Austa
- E-Capitol
- E-Sovica-A
- E-Sovica-O
- E-Sovica-N
- E-Corium
- E-Tri
- E-Yes
- E-Platz
- E-Max
- E-Noble 2.0
- E-Valenti



SYSTEM SERIES

DESKING

- Sovica-A
- Sovica-O
- Sovica-N
- Corium

MODULAR

- Mente

PANEL SERIES

- Flex
- Fonte II

HEIGHT ADJUSTABLE

- Evo
- Revostand

MEETING & CONFERENCE



5

- Yes
- Sovica-A
- Sovica-N
- Salsa
- Oro
- Perform

RECEPTION



- Ava
- Frontis Ad_Maiora

FILING & STORAGE



7

- Norma
- Premio
- Locker 2.0
- Cubo
- Muro
- We Space



8

- Task & Work
- Executive
- Training, Visitor & Conference
- Lounge
- Stool
- Occasional
- Coffee Table

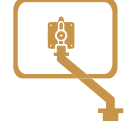

9

ACCESSORIES

- Power Option
- Monitor Arm



1

ACOUSTICS

TELE-POD 2.0



ACOUSTICS



Privacy on Demand

Private & Functional

Privacy-focused spaces are increasingly sought after. The Telepod 2.0, an acoustic phone booth, caters to the need for private and confidential phone calls and video conferences, especially in open-plan office settings. It represents the latest trend in sound management solutions, offering employees a serene, private, and efficient workspace.



LED Neon Strip Light with Dimmer System



Motion Sensor



Standing Height Table



Ventilation System



Making a phone call has become comfortable

Office phone calls and respite has never been more comfortable and this is exactly what we provide.

Features

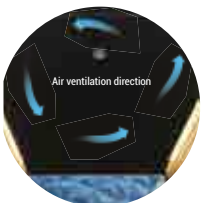

Efficient Airflow

Building- independent ventilation of the product developed in Germany.



Easy to Relocate

Mobile pods equipped with heavy-duty casters and levelers offer effortless relocation and can be easily adjusted to accommodate uneven floors.



Magnetic Closure

Top and Bottom magnetic door latches that minimize door slamming and securing the door in place.



Comfortable Ambience

Adjustable Controller LED Dimmer Switch For Dimmable Lights.



Smart Connectivity

A & H Meyer Netbox M with Universal Power Socket & USB Charger 3.0 & Type C.

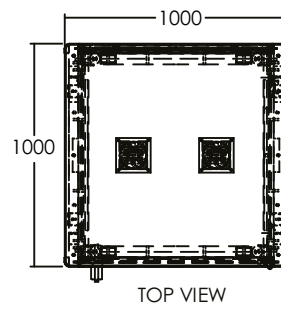
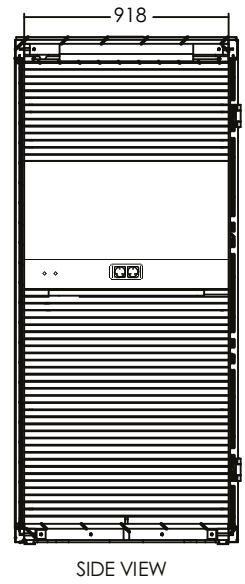
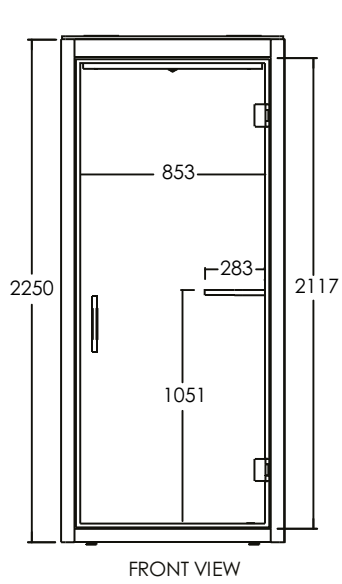

Chair Option



Sella Sit Stool
CUE-HBS-02

or



Zollo High Chair
LOB-HBS-02 (750H)

SHARING POD 2.0



ACOUSTICS



High performance sound absorption to reduce echo and reverberation

Undisturbing, unbroken

Modern workplaces are adapting to the needs of people to work in peace and be more effective.



LED Neon Strip Light
with Dimmer System



Motion Sensor



AH Meyer
Power & USB



Ventilation System



Acoustics, Soundproof

Functional solution and easy to install

A phone booth with many options to choose from. Convenient to sit down comfortably for one-on-one meetings in private or a getaway workplace without disturbance. The exceptional acoustics and physical comfort allow for better communication, as well as concentration.

Time to brainstorm

If you need a place for brainstorming or one to one conversation in an open space, the Sharing Pod is the perfect place for holding meetings without disturbance.



CUE-A-PB-220B-DK1



CUE-A-PB-220B-DK2



CUE-A-PB-220B-DK3



CUE-A-PB-220B-DK4

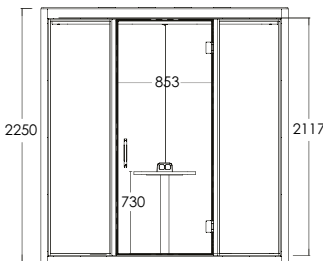

Fixed Center Table

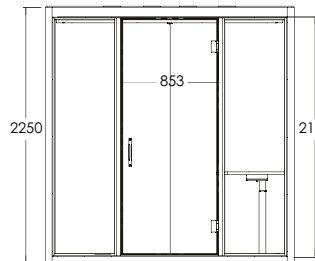

Height Adjustable Table

Height (mm): min. 675 / max. 1110
 Stroke (mm): 490
 Speed (mm/s): 39
 Dynamic Capacity (kg): 60
 Noise dB (A): <50

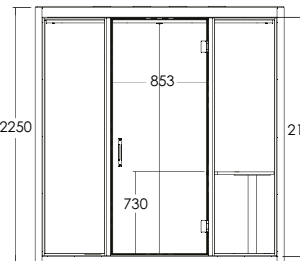

Fixed Side Table

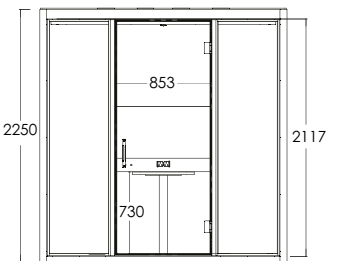

Fixed Center Table with Back Panel

Furniture Option



Flow Chair
CUE-CH-817D

or



Upholstery Sofa

COMPACT POD (MEET)





Modern Workspace with its Unique Design

Informal Meetings, Impromptu & Under 4 People

Compact Pods are increasingly becoming places to collaborate and socialize, so the need for meeting spaces is ever-growing. These quality spaces are for collaboration, relaxation, focus space for concentration, and the design has become a sleeker aesthetic with a strong and modular design.

COMPACT POD (WORK)





Reconfigurable & Extendable

Modular Workspace Open Pods

Dedicated quiet spaces are a necessity within the high-tech buzz of the modern working environment. Sometimes you just need to be alone. Whether you're in need of a solitary space for private conversation or high focus working, the Compact Pod provides facility for this.

OFFICE POD





Private space without leaving the office

Variety & Easy to Fit

Office Pod provides modular, quiet spaces in open office settings, perfect for making phone calls or video meetings in peace. Our pods are available in a variety of sizes, configurations and colors, and are easy to assemble and use



LED Ceiling Light



Standing Height Table



AH Meyer Power & USB



Ventilation System



Features



Air Ventilation



Foldable Laptop Table

More free space



LED Lightings

Energy Efficient



Simple Plug & Play Connection



Sleek Door Handle

Ease of use



Magnetic Closure & Door Seal

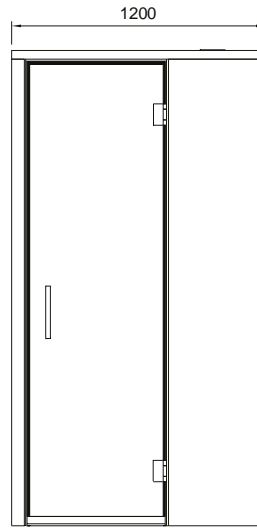

FRONT VIEW

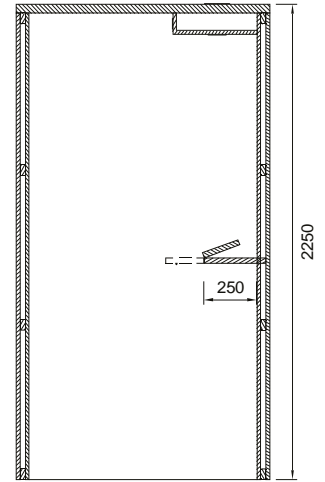

SIDE VIEW

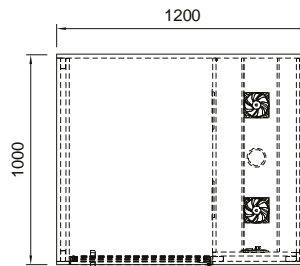

TOP VIEW

Chair Option



Sella Sit Stool
CUE-HBS-02

or



Zollo High Chair
LOB-HBS-02 (750H)

FOCUS QUIET



Focus Quiet
2400 x 2400mm
CUE-PB-240-240B

Live in the real world!

Diffuse the situation

Our focus quiet rooms are equipped with good ventilation system, lighting and even built-in furniture. The rooms are ideal for moderately loud offices, with the aim of creating additional separate areas.



FOCUS QUIET



ACOUSTICS - ROOM COLLECTION

Focus Quiet
3000 x 3000mm
CUE-PB-300-300B



Mobile Portable Spaces

Help to Adapt the Unexpected

We are living in an era of unprecedented where we must be adaptive. Think of these rooms as long-term asset that gives you on going flexibility. They're mobile, some modular. Rather than locking you into a fixed layout, our Acoustic Rooms allow you to tweak the office set up in time, giving you options.

FOCUS QUIET





Focus Quiet
3000 x 4500mm
CUE-PB-450-300B

100% Focus & Concentrate

Acoustic Meeting Room (Up to 8 persons)

Set up larger functional rooms anytime by equipping them with your desired furniture simply by adding or removing. A formal uninterrupted meeting with glass panels that have all been thought out. The sizes vary from 2.4 to 6 meters in length. Customizable furniture. One space.

FOCUS QUIET





Portable Meeting Set Up

Acoustic Meeting Room (Up to 12 persons)

Portable office work pods are an economical alternative to construction. They eliminate the need for costly, time-intensive build outs and renovations. They make quick layout modifications possible. And because they come with you through every move, you'll never be forced to cut your losses, leaving expensive infrastructure behind.



ARCHITECTURAL & SPACE DIVISION

FONTE I





Expand, Re-engineered

Rome wasn't build in a day. Fonte can.

Fonte high walls system are conscientiously engineered to adapt a balance between design and function. The visual unification between architecture walls and office furniture reveals an inspiring harmonious space in today's work environments.

Experience economical ways to expand or re-design your office with this cost effective solution. Ease of modular construction and simple installation with these highly re-adaptable and re-configurable solutions.

Fonte is a breakthrough alternative to traditional construction and design paradigms. Build your very own functional space that promotes efficiency and productivity in your workspace.



Unlimited possibilities with our signature wall panels

Fonte walls system enables you to change when and wherever you need to, with minimal errors compared to conventional construction.

Thoughtful integration with flexible design applications tailored to help enhance your interior environments. These sustainable wall panels will help anticipate your changes while sustaining the planet.





- 1 GLASS PANEL**
- 1.1 Variable Height (Single Glass)
 - 1.2 Variable Height with Transom (Single Glass)
 - 1.3 Multi-Segment (Single Glass / Double Glass)

- 2 SOLID PANELS**
- 2.1 Variable Height
 - 2.2 Variable Height with Transom
 - 2.3 Multi-Segment

*(MFC Panel / MFC Sound Absorbing Panel /
HPL Panel / HPL Sound Absorbing Panel / Fabric Panel)*

- 3 COMBINATION PANEL**
- Variable Height with Single Glass

- 4 INTERFACE PANEL**
- Painted Glass with **(MFC / HPL / Fabric)**



5

DOOR

- 5.1 All MFC / HPL with Chipboard Door
- 5.2 Combined MFC/HPL with Full Glass Door
- 5.3 Combined MFC/HPL with Half Glass Door
- 5.4 Combined MFC/HPL with Privacy Glass
- 5.5 All Glass Door
- 5.6 Sliding Glass Door

6

WIRE MANAGEMENT

- Wire Way Profile for Ceiling System

FEATURES

Wall System



01 Ceiling & Integrated Floor Connection

Lock the panel system to the building ceiling grid or finished ceiling
Non-marring
Re-locatable/reusable
Adjustable floor track available with either a non-marring carpet gripper or non-marring smooth shoe for hard floor applications.



02 Top Cuttable Panels

Offers custom fit to irregular ceiling conditions
Custom scribed to building detail on site
Available in solid and glass/solid combination panels



03 Side Cuttable Panels

Offers flexibility in width
Custom scribed to building detail on site
Available in solid panels only

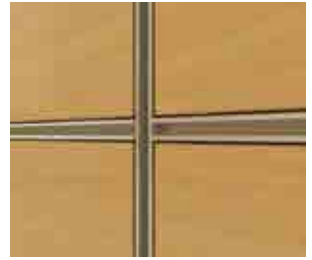

04 Reveal Connectors

Clean, consistent reveals
Available in 2 options

Glass Details



05 2 Way 90° Glass Corner



06 3 Way 90° Glass Corner



07 Butt Glass Joint

Technical Guide



08 Simple clip are used to secure boards onto the metal frame.



09 Partition frames are covered with skirting for a touch of elegance. The height adjustable in +/- 20mm



10 Adjustable glides allows to stabilize structure both onto the ceiling and onto the floor.

Glass Door



11 Door Handle for Glass Door

Door Lock



12 Knob Forma F13

Hinge Options



13 Wood or Metal, Butt Hinge

Hinge Options



14 Glass Slab, Butt Hinge

Accessories



15 Closures + Automated Opener



16 Door Stop

Finishing Options



17 MFC



18 Acoustic Panel



19 HPL



20 Painted Glass



21 Fabric



EXECUTIVE SERIES



EXECUTIVE SERIES

| SE-EVOKE



SE-EVOKE



EXECUTIVE SERIES

Standard Desk (Left)

EX-EVO-SDB32L

L 3200 x W 2400 x H 760 mm

Storage Cabinet

EX-EVO-SCW32

L 3200 x W 450 x H 2100 mm

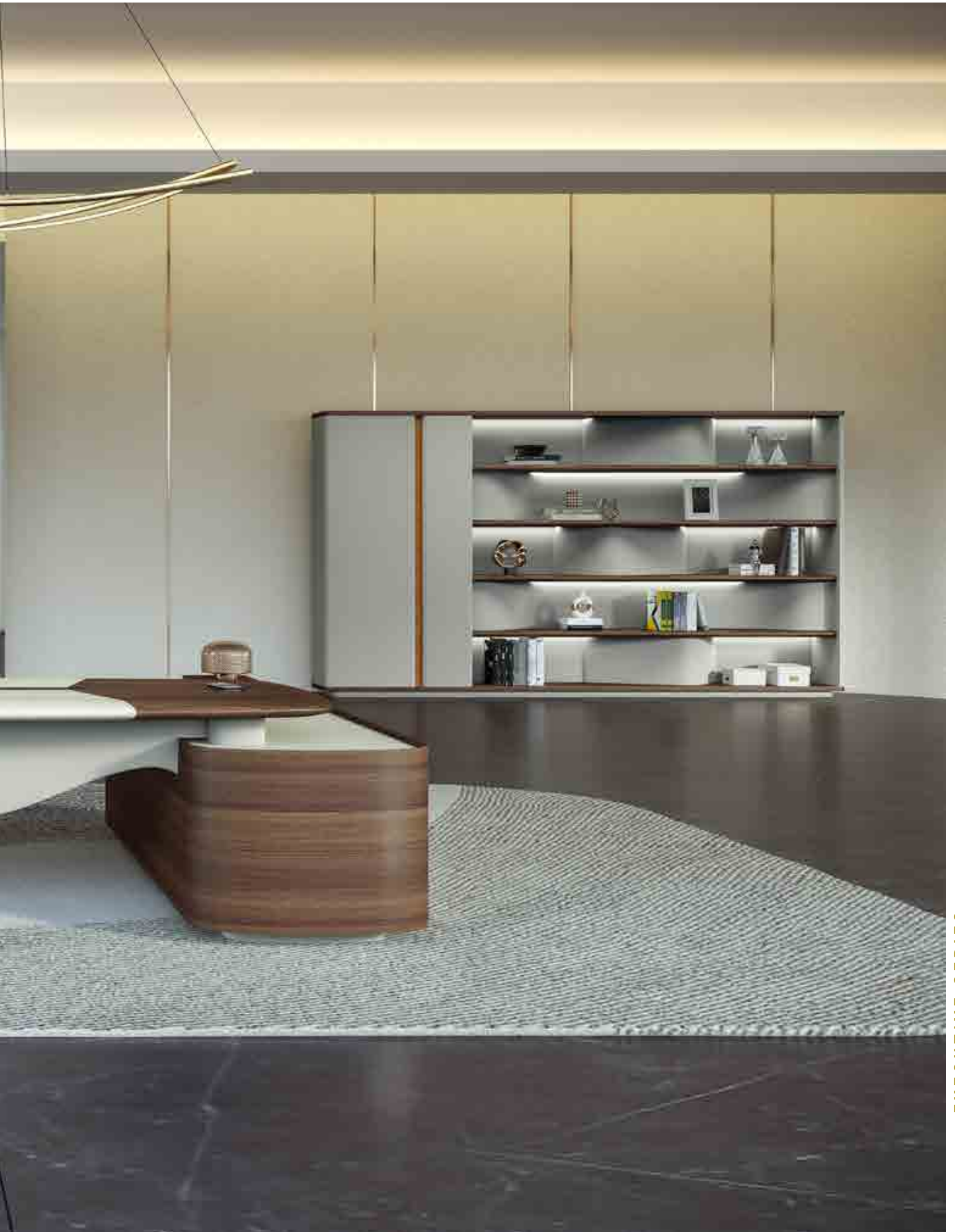



Standard Desk

EX-EVO-SDB32L

L 3200 x W 2400 x H 760 mm



Noble and Elegant Shape

Soft and Beautiful Touch

Make everything comfortable & natural. The infinite glory of yesterday, the glory of tomorrow. Interpret today's classic fashion in your elegance.



All ideas are inspired by life

The starting point of everything is also for the comfort of our work and life.

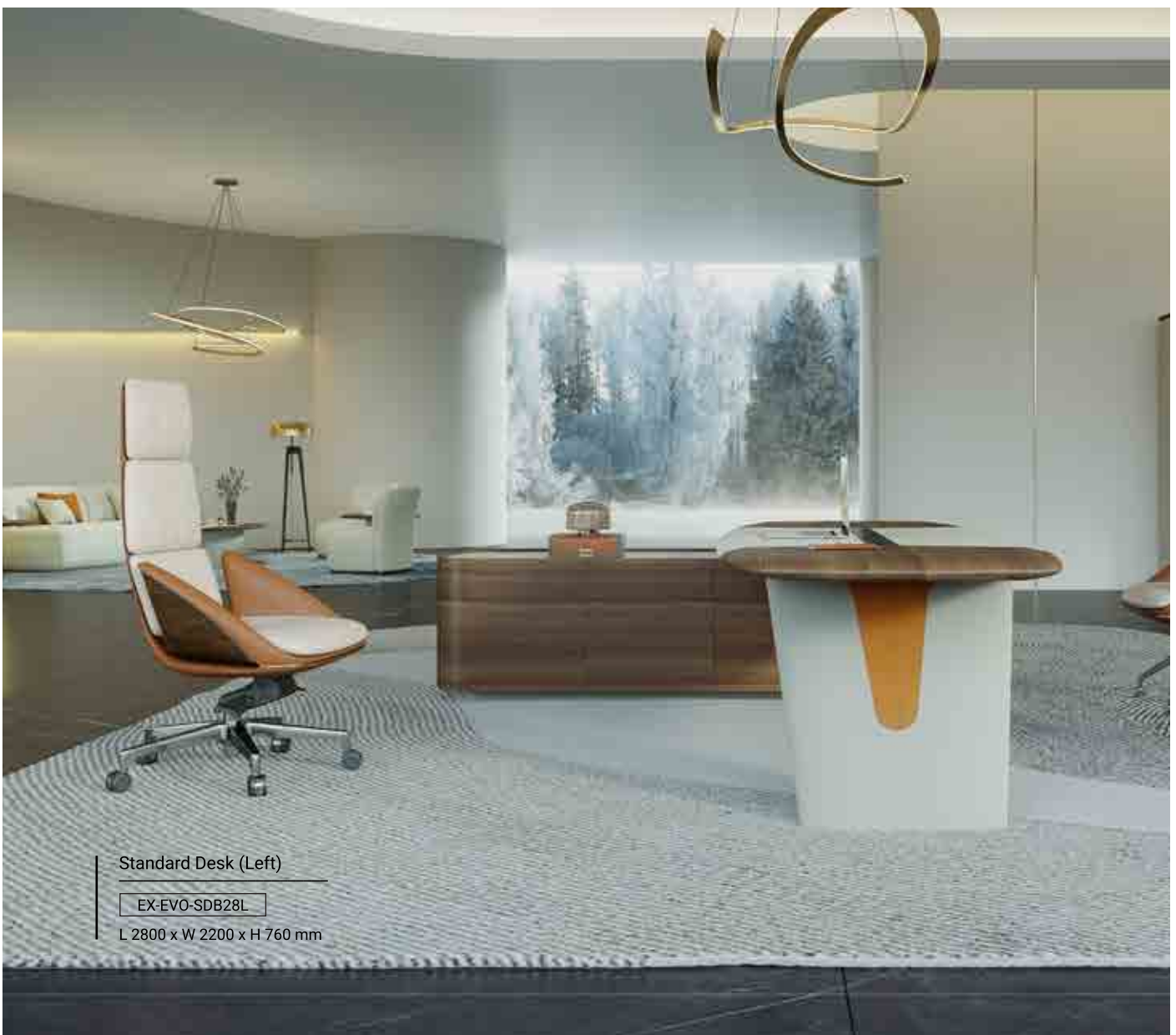

Standard Desk (Left)

EX-EVO-SDB28L

L 2800 x W 2200 x H 760 mm



Storage Cabinet

EX-EVO-SCW32

L 3200 x W 450 x H 2100 mm



Gongfu Coffee Table

EX-EVO-GCT16

L 1650 x W 700 x H 550 mm

Round Coffee Table

EX-EVO-RCT7W

Ø 700W x H 500 mm





Standard Desk (Right)

EX-EVO-SDB32R

L 3200 x W 2400 x H 760 mm

EX-EVO-SDB28R

L 2800 x W 2200 x H 760 mm



Storage Cabinet

EX-EVO-SCW32

L 3200 x W 450 x H 2100 mm



Storage Cabinet

EX-EVO-SCW32

L 3800 x W 450 x H 2200 mm



Meeting Table

EX-EVO-MT32

L 3200 x W 1300 x H 760 mm



Meeting Table

EX-EVO-MT42

L 4200 x W 1600 x H 760 mm



Round Discussion Table

EX-EVO-RDT10

∅ 1000 W x H 750 mm



Tea Cabinet Low

EX-EVO-TC20

L 2000 x W 4500 x H 910 mm



Tea Cabinet Divider

EX-EVO-TCD24

L 2400 x W 400 x H 1775 mm



Bar Counter

EX-EVO-BC26

L 2670 x W 1200 x H 1050 mm



Oval Shape Coffee Table

EX-EVO-OSCT15

L 1500 x W 750 x H 400 mm



Round Coffee Table

EX-EVO-RCT7W

∅ 700W x H 500 mm



Gongfu Coffee Table

EX-EVO-GCT16

L 1650 x W 700 x H 550 mm



Gongfu Coffee Table

EX-EVO-GCT20

L 2000 x W 900 x H 720 mm



Functional Table

EX-EVO-FT60

L 600 x W 400 x H 640 mm



Tea Cabinet Full Height

EX-EVO-TCFH24

L 2400 x W 400 x H 1800 mm



EXECUTIVE SERIES

| SE-FAME

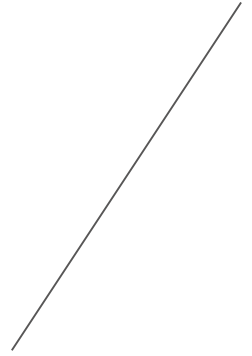

SE-FAME

LEADERSHIP OFFICES

EXECUTIVE SERIES

Standard Desk (Right)

EX-FM-SD26R

L 2600 x W 2040 x H 760 mm

Storage Cabinet

EX-FM-SCWA30

L 3000 x W 420 x H 1900 mm







EXECUTIVE SERIES

Meeting Table

EX-FM-MTT30

L 3000 x W 1200 x H 760 mm







Standard Desk (Left)

EX-FM-SD32L
L 3200 x W 2300 x H 760 mm
EX-FM-SD28L
L 2800 x W 2300 x H 760 mm



Standard Desk (Right)

EX-FM-SD32R
L 3200 x W 2300 x H 760 mm
EX-FM-SD28R
L 2800 x W 2300 x H 760 mm



Storage Cabinet

EX-FM-SCWA32
L 3200 x W 420 x H 2000 mm



Storage Cabinet

EX-FM-SCWB38
L 3800 x W 420 x H 2150 mm



Display Storage Cabinet

EX-FM-DSWC32
L 3240 x W 400 x H 1960 mm



Tea Cabinet Low

EX-FM-TC24
L 2400 x W 450 x H 860 mm



Round Discussion Table

EX-FM-RDT09
ø 900 W x H 760 mm



Meeting Table

EX-FM-MTT36
L 3600 x W 1400 x H 760 mm



Meeting Table

EX-FM-MTT48
L 4800 x W 1600 x H 760 mm



Square / Long Coffee Table

EX-FM-SCT07
L 700 x W 700 x H 420 mm
EX-FM-LCT14
L 1400 x W 700 x H 420 mm



Gongfu Coffee Table

EX-FM-GCT16
L 1600 x W 750 x H 600 mm



Functional Table

EX-FM-FTCT20
L 2050 x W 1300 x H 700 mm



EXECUTIVE SERIES

| SE-LUSH

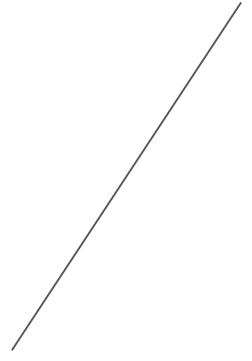

SE-LUSH



EXECUTIVE SERIES

Standard Desk (Left)

EX-LUS-SD32L

L 3200 x W 2700 x H 760 mm

Standard Desk (Left)

EX-LUS-SD28L

L 2800 x W 2500 x H 700 mm



Storage Cabinet

EX-LUS-SCW36

L 3640 x W 450 x H 2100 mm



Storage Cabinet

EX-LUS-CCW46

L 4600 x W 400 x H 3000 mm





Meeting Table

EX-LUS-MTT46

L 4600 x W 1800 x H 760 mm









Tea Table

EX-LUS-TTC20

L 2000 x W 863 x H 680 mm

Tea Cabinet High

EX-LUS-TCHW26

L 2640 x W 400D x H 1850 mm





Standard Desk (Left)

EX-LUS-SD32L

L 3200 x W 2700 x H 760 mm

EX-LUS-SD28L

L 2800 x W 2500 x H 760 mm



Storage Cabinet

EX-LUS-SCW36

L 3640 x W 450 x H 2100 mm



Customised Cabinet

EX-LUS-CCW46

L 4600 x W 400 x H 3000 mm



Meeting Table

EX-LUS-MTT46

L 4600 x W 1800 x H 760 mm



Meeting Table

EX-LUS-MTT36

L 3600 x W 600 x H 760 mm



Tea Cabinet Low

EX-LUS-TCLC17

L 1780 x W 400 x H 850 mm



Coffee Table

EX-LUS-CTQ14

L 1400 x W 900 x H 400 mm



Square Coffee Table

EX-LUS-SCT07

L 750 x W 750 x H 520 mm



Stool

EX-LUS-SF927X1

L 410 x D 410 x H 420 mm



Tea Cabinet High

EX-LUS-TCHW26

L 2640 x W 400D x H 1850 mm



Tea Table

EX-LUS-TTC20

L 2000 x W 863 x H 680 mm



Functional Table

EX-LUS-FTC05

L 580 x W 460 x H 650mm



Highback Chair

EX-LUS-HBF927A1

L 760 x D 630 x H 1190/1255 mm



Medium Back Chair

EX-LUS-MBF927B1

L 760 x D 630 x H 1040/1105 mm



Visitor Chair

EX-LUS-VCF927C1

L 760 x D 630 x H 1040/1105 mm



4 Seater Sofa

EX-LUS-4S266A31

L 2780 x D 1020 x H 660/850 mm



Single Seater Sofa

EX-LUS-SS266A11

L 1120 x D 1020 x H 660/850 mm

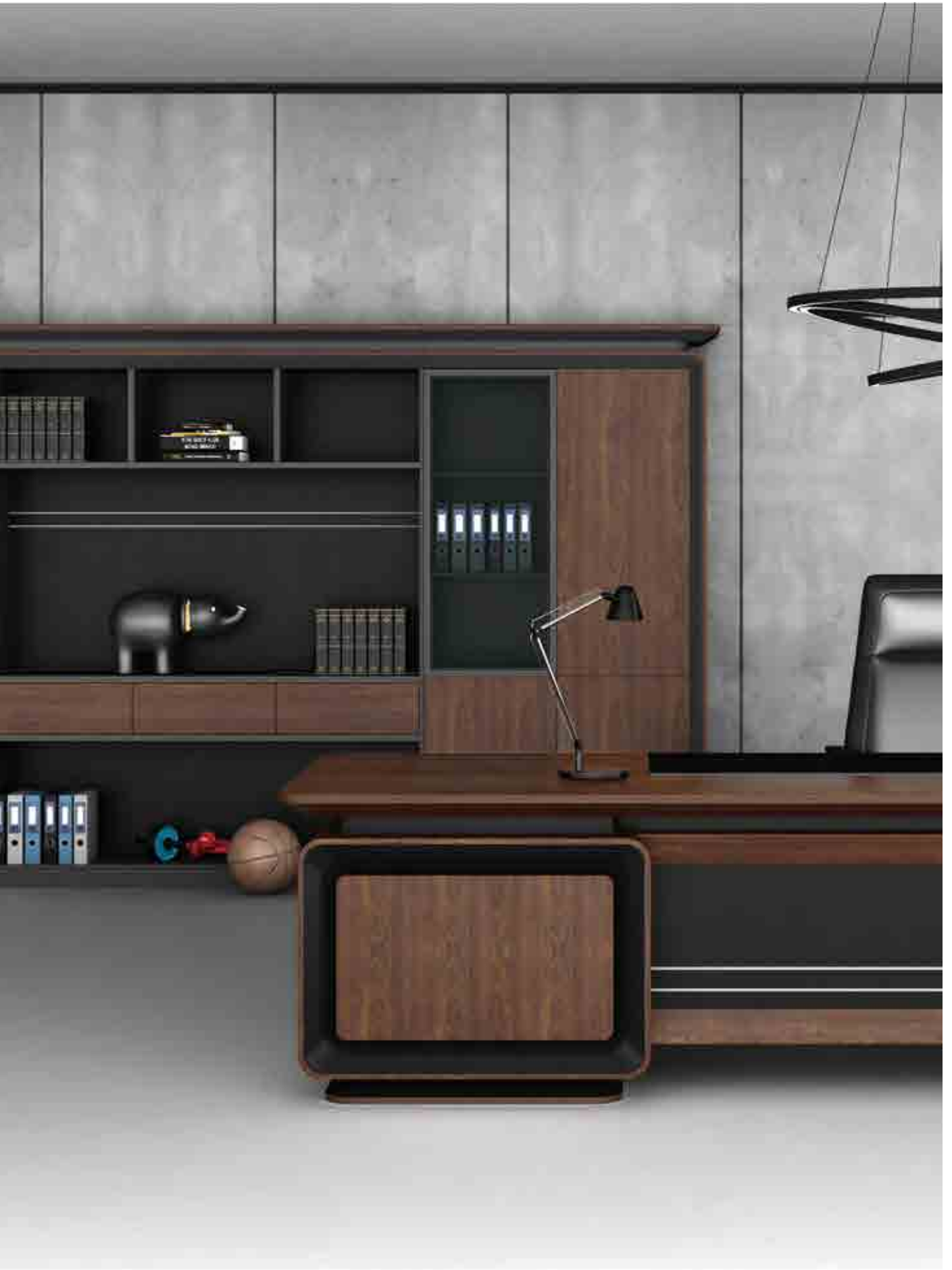

EXECUTIVE SERIES

| SE-PRESTA

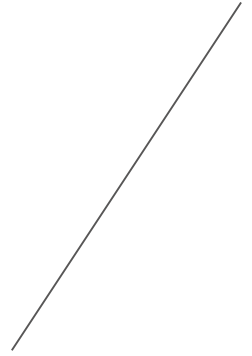

SE-PRESTA



EXECUTIVE SERIES

Standard Desk

EX-PST-SDB28

L 2800 x W 1150 x H 760 mm

Standard Desk

EX-PST-SDB32

L 3200 x W 1150 x H 760 mm



Storage Cabinet

EX-PST-SCW39

L 3900 x W 450 x H 2100 mm

Storage Cabinet

EX-PST-SCW32

L 3200 x W 450 x H 2100 mm



Highback Chair

EX-PST-HBF207A1

L 700 x W 680 x H 1180/1240 mm



Medium Back Chair

EX-PST-MBF207B1

L 685 x W 700 x H 1200/1260H mm



Standard Desk

EX-PST-SDB32
L 3200 x W 1150 x H 760 mm



Storage Cabinet

EX-PST-SDB32
L 3900 x W 450 x H 2100 mm



Tea Cabinet Low

EX-PST-SDB32
L 1500 x W 1500 x H 800 mm



Meeting Table

EX-PST-MTT46
L 4600 x W 1800 x H 760 mm



Meeting Table

EX-PST-MTT36
L 3600 x W 1500 x H 760 mm



Tea Cabinet Low

EX-PST-SDB32
L 1500 x W 1500 x H 800 mm



Long Coffee Table

EX-PST-LCTQ16
L 1600 x W 800 x H 450 mm



Square Coffee Table

EX-PST-SCTQ08
L 800 x W 800 x H 500 mm



3 Seater Sofa

EX-PST-3S234A31
L 2230 x W 930 x H 890 mm



Single Seater Sofa

EX-PST-SS234A11
L 1120 x W 930D x H 890 mm



EXECUTIVE SERIES

| SE-ROYALTA

SE-ROYALTA

NEW CHINESE STYLE

EXECUTIVE SERIES

Gongfu Coffee Table

EX-ROY-SDS28

L 1650 x W 700 x H 550 mm

Storage Cabinet

EX-ROY-SCS02

L 900 x W 400 x H 2000 mm

Storage Cabinet

EX-ROY-SCS12

L 900 x W 400 x H 2000 mm





Tea Cabinet Low

EX-ROY-TCL160

L 1600 x W 400 x H 800 mm







Standard Desk

EX-ROY-SDS28
L 2780 x W 1100 x H 760 mm



Tea Cabinet Low

EX-ROY-TCL160
L 1600 x W 400 x H 800 mm



Long Coffee Table

EX-ROY-LCTHSC
L 1200 x W 600 x H 450 mm



Square Coffee Table

EX-ROY-SCTHSD
L 600 x W 600 x H 450 mm



Storage Cabinet

EX-ROY-SCS02
L 900 x W 400 x H 2000 mm



Storage Cabinet

EX-ROY-SCS12
L 900 x W 400 x H 2000 mm



Tea Table

EX-ROY-TTHST
L 1600 x W 800 x H 760 mm



Single Seat Sofa

EX-ROY-VCSF01A
L 770 x W 770 x H 840 mm



Three Seater Sofa

EX-ROY-VCSF03A
L 1900 x W 770 x H 840 mm



Highback Chair

EX-ROY-HBFCBAA



Medium Back Chair

EX-ROY-MBFCBAA



| SE-EMPOWER

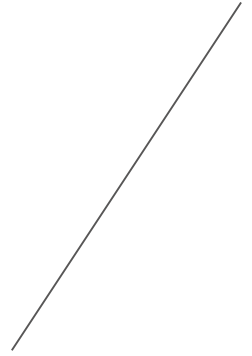

SE-EMPOWER



EXECUTIVE SERIES

Standard Desk (Height Adjustable)

EX-EPW-SDHA32R/L

L 3200 x W 2550 x H 760 mm

Standard Desk (Height Adjustable)

EX-EPW-SDHABA28R/L

L 2800 x W 2400 x H 760 mm



Standard Desk

EX-EPW-SD32R/L

L 3200 x W 2550 x H 760 mm

Standard Desk

EX-EPW-SD28R/L

L 2850W x W 2400D x H 760 mm



Meeting Table

EX-EPW-MTT48

L 4800 x W 1800 x H 760 mm





EXECUTIVE SERIES



EXECUTIVE SERIES



Standard Desk

EX-EPW-SDC24

L 2400 x W 800 x H 850 mm



Standard Desk (Right)

EX-EPW-SD32R

L 3200 x W 2550 x H 760 mm

EX-EPW-SD28R

L 2800 x W 2550 x H 760 mm



Standard Desk (Left)

EX-EPW-SD32L

L 3200 x W 2550 x H 760 mm

EX-EPW-SD28L

L 2800 x W 2550 x H 760 mm



Standard Desk Height Adjustable (Left/Right)

EX-EPW-SDHABA28L/R

L 2800 x W 2400 x H 760 mm

EX-EPW-SDHA28L/R

L 3200 x W 2550 x H 760 mm



Storage Cabinet

EX-EPW-SCW39

L 3980 x W 500 x H 2150 mm

EX-EPW-SCW33

L 3380 x W 480 x H 2050 mm



Storage Cabinet

EX-EPW-SCW32

L 3240 x W 400 x H 1960 mm



Meeting Table

EX-EPW-MTT48

L 4800 x W 1800 x H 760 mm

EX-EPW-MTT60

L 6000 x W 2000 x H 760 mm



Bar Table

EX-EPW-BT16

L 1600 x W 750 x H 600 mm



Tea Cabinet Low

EX-EPW-TCL20

L 200 x W 450 x H 860 mm



Bar Counter

EX-EPW-BC24

L 2400 x W 1800 x H 1600 mm



Coffee Table

EX-EPW-CT08

L 800 x W 500 x H 650 mm



Functional Table

EX-EPW-FTC24

L 2400 x W 800 x H 850 mm



Long Coffee Table

EX-EPW-LCT14

L 1400 x W 750 x H 450 mm



Square Coffee Table

EX-EPW-SCT07

L 700 x W 700 x H 450 mm



EXECUTIVE SERIES

| SE-SUPRA

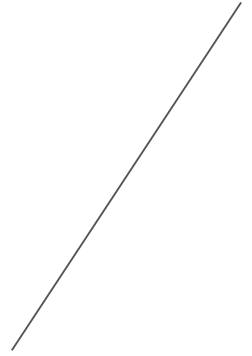

SE-SUPRA



EXECUTIVE SERIES

Standard Desk (Left)

EX-SUP-SDB32L

L 3200 x W 2200 x H 760 mm

Storage Cabinet

EX-SUP-SCW36

L 3600 x W 400 x H 2000 mm







SOFA



Square Coffee Table

EX-SUP-SCTQ10

L 1000 x W 1000 x H 385 mm

Square Coffee Table

EX-SUP-SCTQ07

L 700 x W 700 x H 420 mm



Single Seater Sofa

EX-SUP-SF197A11

L 930 x D 965 x H 715/905 mm

3 Seater Sofa

EX-SUP-SF197A31

L 2030 x D 950 x H 715/905 mm



Meeting Table

EX-SUP-MTT56

L 5600 x W 1800 x H 760mm



MEETING TABLE

EXECUTIVE SERIES



Bar Counter

EX-SUP-BCK28

L 2800 x W 580 x H 1050 mm





Standard Desk (Left)

EX-SUP-SDB32L
L 1600 x W 400 x H 800 mm
EX-SUP-SDB28L
L 2800 x W 2200 x H 760mm



Standard Desk (Left)

EX-SUP-SDB26L
L 2600 x W 2000 x H 760 mm



Storage Cabinet

EX-SUP-SCW30
L 3000 x W 400 x H 2000 mm



Storage Cabinet

EX-SUP-SCW36
L 3600 x W 400 x H 2000 mm



Tea Cabinet Low

EX-SUP-TCLC16
L 1600 x W 400 x H 800 mm



Meeting Table

EX-SUP-MTT48
L 4800 x W 1600 x H 760 mm
EX-SUP-MTT56
L 5600 x W 1800 x H 760 mm



Meeting Table

EX-SUP-MTT36
L 3600 x W 1400 x H 760 mm



Bar Counter

EX-SUP-BCK28
L 2800 x W 580 x H 1050 mm



Long Coffee Table

EX-SUP-LCTQ14
L 1400 x W 700 x H 420 mm



Square Coffee Table

EX-SUP-SCTQ10
L 1000 x W 1000 x H 385 mm



Square Coffee Table

EX-SUP-SCTQ07
L 700 x W 700 x H 420 mm



3 Seater Sofa

EX-SUP-SF197A31
L 2030 x D 950 x H 715/905 mm



Single Seater Sofa

EX-SUP-SF197A11

L 930 x D 965 x H 715/905 mm



Highback Chair

EX-SUP-HBF216A1

L 690 x D 650 x H 1240/1200 mm



Medium Back Chair

EX-SUP-MBF216B1

L 690 x D 650 x H 700/640 mm



Visitor Chair

EX-SUP-VCF216C1

L 690 x D 650 x H 680 mm



EXECUTIVE SERIES

| SE-INSPIRA

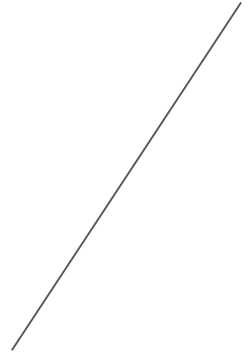

SE-INSPIRA



EXECUTIVE SERIES

Standard Desk (Left)

EX-INS-SDC32L

L 3200 x W 2400 x H 760 mm

Standard Desk (Right)

EX-INS-SDC32R

L 3200 x W 2400 x H 760 mm



Meeting Table

EX-INS-MTT48

L 4800 x W 1600 x H 760 mm

Meeting Table

EX-INS-MTT36

L 3600 x W 1380 x H 760 mm



Standard Desk (Left)

EX-INS-SDC28L

L 2800 x W 2200 x H 760 mm





Standard Desk

EX-INS-SDE28

L 2800 x W 2200 x H 760 mm



Standard Desk

EX-INS-SDA16

L 1600 x W 800 x H 760 mm

Standard Desk

EX-INS-SDA18

L 1800 x W 900 x H 760 mm

Standard Desk

EX-INS-SDA20

L 2000 x W 2200 x H 760 mm



Storage Cabinet

EX-INS-SCW34
L 3440 x W 416 x H 2000 mm



Storage Cabinet

EX-INS-SCW29
L 2900 x W 416 x H 2000 mm



Storage Cabinet

EX-INS-SCW26
L 2600 x W 416 x H 2000 mm



Tea Cabinet

EX-INS-TC12
L 1200 x W 416 x H 1200 mm



Tea Cabinet Low

EX-INS-TCL16
L 1600 x W 400 x H 800 mm



Discussion Table

EX-SUP-TCLC16
L 1600 x W 400 x H 800 mm



Square Discussion Table

EX-INS-DTT09
L 900 x W 900 x H 750 mm



Standard Desk

EX-INS-SDA12
L 1200 x W 600 x H 750 mm



Standard Desk

EX-INS-SDA14
L 1400 x W 700 x H 750 mm



Square Discussion Table

EX-INS-LCTQ14
L 1400 x W 700 x H 500 mm



Square Coffee Table

EX-INS-SCTQ07
L 1200 x W 600 x H 750 mm

SE - LEGATO 2.0



EXECUTIVE SERIES



Executive Desk with Single Leg & Side Return

EX-LTO-F-SD225R

L 2250 x W 2000 x D1 900 x D2 700 x H 750 mm

Inspiration, Motivation

Trusting and Serious Appearance

The timeless and very modern table construction, Legato functions not only as a solitaire, but also as a complicated job solution that is suitable to all technical demands. Legato creates an atmosphere of inspiration and motivation.



A perfect stage for the floating table

The clear separation of the table elements offers independent and free structure. The clarity and straight materials extravagantly finishes as a bridge construction that can be adapted functionally and aesthetically.

Striking, Contrast

The almost all-black ensemble

The combination of the highest quality materials surfaces with a mix and match black ensemble



Executive Desk with Single Leg & Side Return

EX-LTO-F-SD245

L 2450 x W 2000 x D1 900 x D2 600 x H 750 mm

SE - VERVE 2.0





Executive Desk with Single Leg & Side Return

EX-LTO-F-SD245

L 2450 x W 2000 x D1 900 x D2 600 x H 750 mm

Representative, Optics

The classic under chief rooms

Classic Elegance, unusual forms and representative optics, VERVE gives a timeless and noble charisma to the chief room. The generous leather board is convincing by the offer and the front elements completes the harmonious impression of the desk ensemble.



Attractive formed foundation

The unusual forms of the leather covered side panels boards characterized a new concept of office work. It adds elegance and gives the chief room an impressive Italian design office desk.

Top quality performance

New concept of office work and however the work is performed and in whatever way it changes over time, VERVE is just classic elegance.



Executive Desk with Single Leg & Side Return

EX-LTO-F-SD245

L 2450 x W 2000 x D1 900 x D2 600 x H 750 mm

SE - HOUSTON





With Style, and Value

**We listened to the people who
works in the office**

Ergonomics with style and value can also be implemented in the management area. Informal communication while standing saves time and is the most important interface in every company.



A desk has to be more than a table

A sophisticated well thought out system with which you can organize your office individually - multifunctional with a wealth of variants, ergonomically and convenient to use.

Focus on user orientated

To achieve the maximum is by reducing to a minimum. A little table as necessary and as much user orientated functions as possible to fulfill maximum variability, functionalism, ergonomics and sustainable office furnishing.



SE - PRESIDENT



EXECUTIVE SERIES

Type E Side Return

EX-PSD-E-HAD260

L 2602 x W 2000 x D1 900 x D2 600 x H 750 ~ 1150 mm



Highest, Degree of Freedom

**A good office means
motivation**

Anybody who works daily at a desk knows best which contribution furniture is desirable to simplify work to an optimum in the office. PRESIDENT series is the perfect table system which is transformable from a single executive table to a mix of standing, sitting and in between movement thus creating that multifunctional free hand that is rich in variety.



A desk honed to perfection

Easily adaptable with wide options of storages, PRESIDENT is a well-made executive series that shows sophistication delicately.

Being creative means staying in motion

Regularly alternating between standing and sitting at your workplace has advantages: it strengthens your back and improves your health, as well as your concentration





| E-PRAGMO

E-PRAGMO



EXECUTIVE SERIES

Standard Desk (Right)

EX-PRG-SD26R

L 2600 x W 2040 x H 760 mm

Storage Cabinet

EX-PRG-SCW30

L 3000 x W 420 x H 1900 mm



LIGHT LUXURY AESTHETICS



EXECUTIVE SERIES



Luxury Aesthetics

Works both internally and externally
coexistence of appearance and
function





Discussion Table

EX-PRG-DTT09

L 900 x W 900 x H 760 mm

Tea Cabinet Low

EX-PRG-TCLC12

L 1200 x W 400 x H 800 mm



Harmonious Meeting, Challenging Environment

Creating a harmonious atmosphere for meetings is very important for modern offices. A meeting means the beginning of a challenge. A challenge requires a good environment.



Meeting Table

EX-PRG-MTC36

L 3000 x W 1300 x H 760 mm





Standard Desk (Left)

EX-PRG-SDB24L
L 2400 x W 2040 x H 760 mm



Standard Desk (Left)

EX-PRG-SDB26L
L 2600 x W 2040 x H 760 mm



Storage Cabinet

EX-PRG-SCW26
L 2600 x W 400 x H 1900 mm



Storage Cabinet

EX-PRG-SCW30
L 3000 x W 420 x H 1900 mm



Tea Cabinet Low

EX-PRG-TCLC12
L 1200 x W 400 x H 800 mm



Discussion Table

EX-PRG-DTT09
L 900 x W 900 x H 760 mm



Meeting Table

EX-PRG-MTT24
L 2400 x W 1100 x H 760 mm



Standard Desk (Left)

EX-PRG-SDB26L
L 2600 x W 2040 x H 760 mm



Storage Cabinet

EX-PRG-SCW26
L 2600 x W 400 x H 1900 mm



Long Coffee Table

EX-PRG-LCTQ12
L 1200 x W 600 x H 420 mm

Square Coffee Table

EX-PRG-SCTQ06
L 600 x W 600 x H 420 mm



EXECUTIVE SERIES

| E-UTILIA

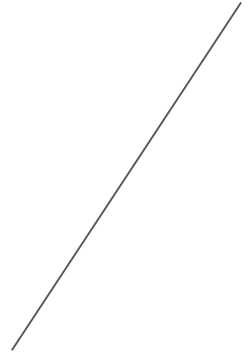

E-UTILIA



EXECUTIVE SERIES

Standard Desk (Right)

EX-UTL-SDB24R

L 2400 x W 1900 x H 750 mm

Storage Cabinet

EX-UTL-SCW28

L 2800 x W 420 x H 2000 mm

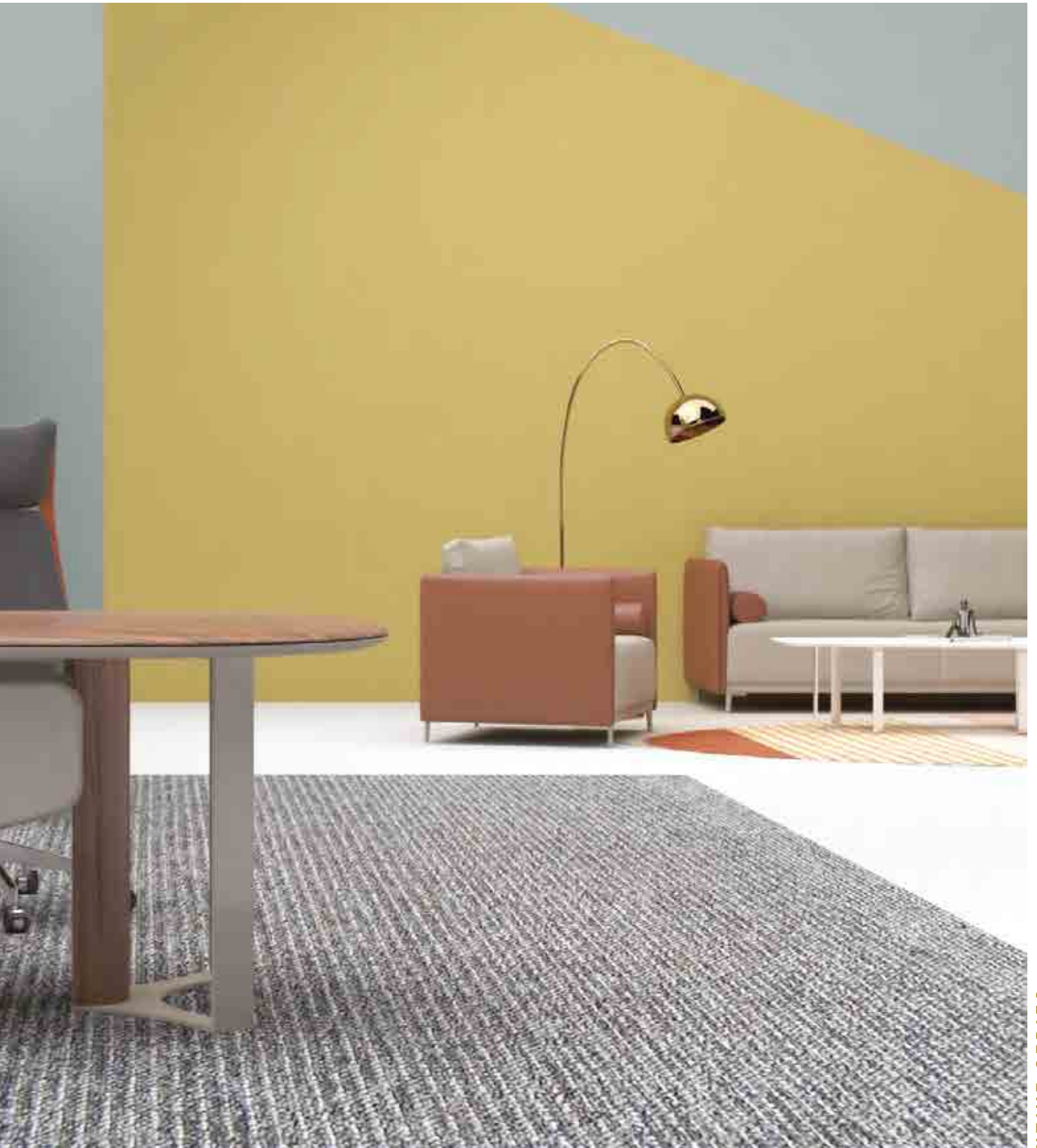





Storage Cabinet

EX-UTL-SCW28
L 2800 x W 420 x H 2000 mm

EX-UTL-SCW24
L 2400 x W 420 x H 2000 mm

Meeting Table

EX-UTL-MTT36
L 3600 x W 1450 x H 750 mm



Single Seater Sofa

EX-UTL-SS263A12

L 980 x W 800 x H 820 mm

3 Seater Sofa

EX-UTL-3SS263A32

L 2080 x W 800 x H 820 mm



By hosting a team meeting, you'll be able to touch upon what people are doing well, giving everyone feedback on how they're doing. If you've never held a team meeting to brainstorm new ideas, try starting with UTILIA meeting table.



MEETING TABLE



Meeting Table

EX-UTL-MTT36

L 3600 x W 1450 x H 750 mm





Standard Desk (Right)

EX-UTL-SDB24R
L 2400 x W 1900 x H 750 mm



Storage Cabinet

EX-UTL-SCW28
L 2800 x W 420 x H 2000 mm
EX-UTL-SCW24
L 2400 x W 420 x H 2000 mm



Meeting Table

EX-UTL-MTT36
L 3600 x W 1450 x H 750 mm



Meeting Table

EX-UTL-MTT45
L 4500 x W 1650 x H 750 mm



3 Seater Sofa

EX-UTL-3SS263A32
L 2080 x W 800 x H 820 mm



Single Seater Sofa

EX-UTL-SS263A12
L 980 x W 800 x H 820 mm



EXECUTIVE SERIES

| E-AUSTA

E-AUSTA



EXECUTIVE SERIES



Standard Desk (Left)

EX-AUS-SD305L

L 3050 x W 1800 x H 760 mm

Storage Cabinet

EX-AUS-SCC06

L 3400 x W 420 x H 1950 mm



LIGHT LUXURY AESTHETICS

EXECUTIVE SERIES



Functionality and Adaptability

Works both internally and externally co
existence of appearance and function



Single Seater Sofa

EX-AUS-SS42A1

L 1040 x W 850 x H 810 mm

3 Seater Sofa

EX-AUS-3SS42A3

L 2040 x W 850 x H 810 mm



Long Coffee Table

EX-AUS-LCTHCC

L 1400 x W 700 x H 420 mm

Square Coffee Table

EX-AUS-SCTHCD

L 700 x W 700 x H 420 mm



Harmonious Meeting, Challenging Environment

Creating a harmonious atmosphere for meetings is very important for modern offices. A meeting means the beginning of a challenge. A challenge requires a good environment.







Standard Desk (Left)

EX-AUS-SD305L
L 3050 x W 1800 x H 760 mm



Standard Desk (Left)

EX-AUS-SD241L
L 2400 x W 1600 x H 760 mm



Storage Cabinet

EX-AUS-SCC06
L 3400 x W 420 x H 1950 mm



Storage Cabinet

EX-AUS-SCC06
L 2380 x W 400 x H 1800 mm



Meeting Table

EX-AUS-MTTC36
L 3600 x W 1300 x H 760 mm



Tea Cabinet Low

EX-AUS-TCL180
L 1800 x W 400 x H 805 mm



Long Coffee Table

EX-AUS-LCTHCC
L 1400 x W 700 x H 420 mm



Square Coffee Table

EX-AUS-SCTHCD
L 700 x W 700 x H 420 mm



3 Seater Sofa

EX-AUS-3SS42A3
L 2040 x W 850 x H 810 mm



Single Seater Sofa

EX-AUS-SS42A1
L 1040 x W 850 x H 810 mm



EXECUTIVE SERIES

| E-CAPITOL

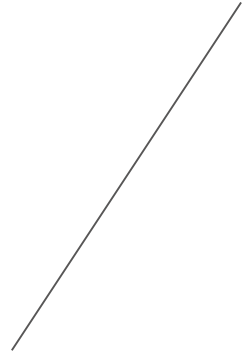

E-CAPITOL



EXECUTIVE SERIES



Standard Desk

EX-CAP-SDB24

L 2400 x W 1800 x H 760 mm

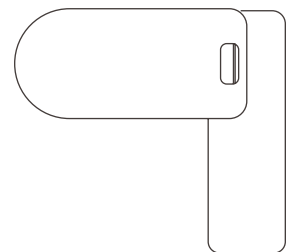
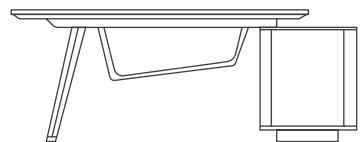



Standard Desk

EX-CAP-SDB20

L 2000 x W 1800 x H 760 mm

Storage Cabinet

EX-CAP-SCW26

L 2600 x W 400 x H 1900 mm

Tea Cabinet Low

EX-CAP-TCLC12

L 1200 x W 400 x H 800mm





Standard Desk

EX-CAP-SDB24

L 2400 x W 1800 x H 760 mm

Storage Cabinet

EX-CAP-SCW26

L 2600 x W 400 x H 1900 mm



Noble and Elegant Shape of Workspace

Soft and beautiful touch, make everything comfortable and natural. The infinite glory of yesterday, the glory of tomorrow. Interpret today's classic fashion in your elegance.





All ideas are inspired by life.

The starting point of everything is also for the comfort of our work and life

Standard Desk

EX-CAP-SDBA18S

L 1800 x W 1600 x H 760 mm

Multi Functional Cabinet

EX-CAP-MFCN12S

L 1200 x W 400 x H 650 mm





Meeting Table

EX-CAP-MTRNT32S

L 3200 x W 1200 x H 760 mm

Long Coffee Table

EX-CAP-LCTQ12

L 1200 x W 600 x H 400 mm

Single Seater Sofa

EX-CAP-SS178A11

L 1000 x W 900 x H 800 mm

3 Seater Sofa

EX-CAP-3SS178A31

L 2100 x W 900 x H 800 mm







Standard Desk

- EX-CAP-SDB20**
L 2000 x W 1800 x H 760 mm
- EX-CAP-SDB24**
L 2400 x W 1800 x H 760 mm



Standard Desk

- EX-CAP-SDBA24S**
L 2400 x W 1800 x H 760 mm
- EX-CAP-SDBA20S**
L 2000 x W 1800 x H 760 mm
- EX-CAP-SDBA18S**
L 1800 x W 1600 x H 760 mm



Standard Desk

- EX-CAP-SDBB16S**
L 1600 x W 800 x H 760 mm
- EX-CAP-SDBB18S**
L 1800 x W 800 x H 760 mm



Tea Cabinet Low

- EX-CAP-TCLC12**
L 1200 x W 400 x H 800 mm



Storage Cabinet

- EX-CAP-SCW26**
L 2600 x W 400 x H 1900 mm



Storage Cabinet

- EX-CAP-SCW21S**
L 2150 x W 400 x H 1900 mm



Meeting Table

- EX-CAP-MTRNT24**
L 2400x W 1200 x H 760 mm



Meeting Table

- EX-CAP-MTRNT36**
L 3600 x W 1300 x H 760 mm



Meeting Table

- EX-CAP-MTRNT32S**
L 2400 x W 1100 x H 760 mm
- EX-CAP-MTRNT24S**
L 3200 x W 1200 x H 760 mm



Tea Cabinet Low

- EX-CAP-TCLC12**
L 1200 x W 400 x H 800 mm



Long Coffee Table

- EX-CAP-LCTQ12**
L 1200 x W 600 x H 400 mm

Square Coffee Table

- EX-CAP-SCTQ06**
L 600 x W 600 x H 400 mm



Single Seater Sofa

- EX-CAP-SS178A11**
L 1000 x W 900 x H 800 mm

3 Seater Sofa

- EX-CAP-3SS178A31**
L 2100 x W 900 x H 800 mm

E-SOVICA A

EXECUTIVE SERIES



Type A Side Return

Executive Desk with Single Leg A and Side Return

EX-SOV-A-DSR180A

L 1800 x W 1600 x D1 800 x D2 500 x H 750 mm

EX-SOV-A-DSR200A

L 2000 x W 1600 x D1 800 x D2 500 x H 750 mm



Symmetrical, Curve

**Bridging the gap between classic
and modern**

E-SOVICA is a collection of executive designed desks with side return. The new market segments with a furnishing solution affording an extraordinary visual impact: SOVICA-A is an executive desk concept with symmetrical curve legs, in black finish, with the possibility of combining a return unit with a pedestal.



Space Divider

Striking collection

SOVICA-A design combines extremely clean cut silhouettes and is available in L-shape desk where the side return is an integrated unit. The side return is a flawless platform organizing cable management and storage units that is designed to contrast aesthetic alternatives.



Integrated Storage

The desk's integrated lateral storage unit has a sliding door in wood. The storage unit offers drawers, open compartments, sections for files and a CPU holder which enables wire access from the desktop.



Type B Side Return

Executive Desk with Single Leg A and Side Return

EX-SOV-B-DSR180A

L 1800 x W 1600 x D1 800 x D2 500 x H 750 mm

EX-SOV-B-DSR200A

L 2000 x W 1600 x D1 800 x D2 500 x H 750 mm

E-SOVICA 0



EXECUTIVE SERIES

Type A Side Return

Executive Desk with Single Leg A and Side Return

EX-SOV-A-DSR1800

L 1800 x W 1600 x D1 800 x D2 500 x H 750 mm

EX-SOV-A-DSR2000

L 2000 x W 1600 x D1 800 x D2 500 x H 750 mm



Bold in Black

Stylish and sturdy design

E-SOVICA 0 · In terms of built, the desk is made with perfect edge technology which makes the desk look gorgeous while also being very sturdy.



Conventional but fashionable

SOVICA-0 series is an executive desk concept with loop legs, in black finish, with the possibility of combining a return unit with a pedestal.



Integrated Storage

The desk's integrated lateral storage unit has a sliding door in the same wood. The storage unit offers drawers, open compartments, sections for files and a CPU holder which enables wire access from the desktop



Type B Side Return

Executive Desk with Single Leg A and Side Return

EX-SOV-B-DSR1800

L 1800 x W 1600 x D1 800 x D2 500 x H 750 mm

EX-SOV-B-DSR2000

L 2000 x W 1600 x D1 800 x D2 500 x H 750 mm

E-SOVICA N



EXECUTIVE SERIES



Superior, Casualness

Consistent overlook

SOVICA Executive offices appeal thanks to their diffident elegance, clear lines and high-quality workmanship. The SOVICA-N series features high-quality design and reduction down to the essentials. A furniture set that takes a back seat and allows the materials, colors and surfaces to take center stage.



Type B Side Return

Executive Desk With Single Leg O and Side Return

EX-SOV-B-DSR180N

L 1800 x W 1600 x D1 800 x D2 500 x H 750 mm

EX-SOV-B-DSR200N

L 2000 x W 1600 x D1 800 x D2 500 x H 750 mm

The elegance of this design

SOVICA-N series is an executive desk concept with goalpost legs, in white finish, with the possibility of combining a return unit with a pedestal.



Quality becomes apparent

SOVICA is designed to be timeless, versatile and long lasting to fit any workshape needed. With its wide range of units, SOVICA-N series offers a great variety of choice from a single executive desk to multiple workstations as well as meeting tables.



Type D Side Return

Executive Desk with Single Leg A and Side Return

EX-SOV-D-DSR200N

L 2000 x W 800 x H 750 mm

EX-SOV-D-DSR200N

L 2200 x W 800 x H 750 mm

E-CORIUM



EXECUTIVE SERIES

Type A Side Return

Executive Desk With Single Leg and Side Return

EX-CRM-A-DSR180

L 1800 x W 1600 x D1 800 x D2 500 x H 750 mm

EX-CRM-A-DSR200

L 2000 x W 1600 x D1 800 x D2 500 x H 750 mm



Luxurious, Elegant

Italian design, desirable

CORIUM has been designed as a complete desk concept. With a modern and elegant touch, Corium executive is clearly identifiable through its Italian engineered metal legs and the well balanced material construed perfectly into an executive room

Individual Chic

The polygon-shaped legs, polished chrome or painted in white, characterizes the entire collection. The junction of its unique leg, elegantly curved, appears as one single piece. The geometrical design hides the complexity of its structure and that gives a feeling of cleanliness and lightness to the Italian designed structure.



Type B Side Return

Executive Desk With Single Leg and Side Return

EX-CRM-B-DSR180

L 1800 x W 1600 x D1 800 x D2 500 x H 750 mm

EX-CRM-B-DSR200

L 2000 x W 1600 x D1 800 x D2 500 x H 750 mm



Standards we believe in

Designed to address current work spaces giving them warmth and distinction. The round shape edge of the table was designed for creating a space for discussion.



E-TRI



EXECUTIVE SERIES

Type C Side Return

Executive Desk With Single Leg and Side Return

EX-TRI-C-DSR180

L 1800 x W 1600 x D1 800 x D2 500 x H 750 mm

EX-TRI-C-DSR200

L 2000 x W 1600 x D1 800 x D2 500 x H 750 mm



Illuminate Beauty

Real suave, real sophisticated

TRI creates sleek feel towards the office environment. It's especially designed to exude both simple and elegant style of function for the executives. Carefully crafted metal leg components create a feeling of and essential linearity.



Stylishness and class

Its stylish legs add a touch of elegance and also enhance the aesthetic of the office. The professional and sleek look also offer spacious storage for effective file management.



TRI is here, seek no more

Specially creted for those who are systematic, with attention to details. It's presented with variety of shapes and sizes to suit your office needs.



Type A Side Return

Executive Desk With Single Leg and Side Return

EX-TRI-A-DSR180

L 1800 x W 1600 x D1 800 x D2 500 x H 750 mm

EX-TRI-A-DSR200

L 2000 x W 1600 x D1 800 x D2 500 x H 750 mm

E-YES



EXECUTIVE SERIES

Type A Side Return

Executive Desk With Single Leg and Side Return

EX-YES-A-DSR180

L 1800 x W 1600 x D1 800 x D2 500 x H 750 mm

EX-YES-A-DSR200

L 2000 x W 1600 x D1 800 x D2 500 x H 750 mm



Lavish, Confident

**Never say no when you really
want to say YES**

YES, incorporates style and efficient use of executive desking. It integrates fine melamine finishing with contrasting arrays of colors and the carefully crafted chrome finished metal legs. It gives a feeling of extravagance but at the same time keeping it hands-on everyday use. It encourages the user feeling pleasant and confident, which is the intention why we made YES to be.



A combination with design

The metal legs are constructed from reinforced tubes that are finished in chrome disguising wire ways in wooden channels offering innovative techniques in it's design.



Chromatic, Support

Functionalism with balance

Through raising the storages with a chromatic pallet close to the base support, the fixed side return is perfected.



Type B Side Return

Executive Desk With Single Leg and Side Return

EX-YES-B-DSR180

L 1800 x W 1600 x D1 800 x D2 500 x H 750 mm

EX-YES-B-DSR200

L 2000 x W 1600 x D1 800 x D2 500 x H 750 mm

E-PLATZ



EXECUTIVE SERIES

Type A Side Return

Executive Desk With Single Leg and Side Return

EX-PTZ-A-DSR180

L 1800 x W 1600 x D1 800 x D2 500 x H 750 mm

EX-PTZ-A-DSR200

L 2000 x W 1600 x D1 800 x D2 500 x H 750 mm



Build Your Character

Innovative, creative, empowering

PLATZ+ is understatement, designed to play down its role in the office environment giving way to people and their daily lives as they build the character of the office with their daily tools of work, creating character by themselves rather than being imposed.

Ideal for working essential, detailed

PLATZ+ is both light and strong. The structural detailing of the frame and legs create a design language. Making it an outstanding feature and it's character of the system. Platz+ legs are available in two colors, black and white.



Type B Side Return

Executive Desk With Single Leg and Side Return

EX-PTZ-B-DSR180

L 1800 x W 1600 x D1 800 x D2 500 x H 750 mm

EX-PTZ-B-DSR200

L 2000 x W 1600 x D1 800 x D2 500 x H 750 mm



Flexibility, dedicated to the need

Single and stand-alone furniture elements makes PLATZ+ flexible and easy to use for dedicated needs.



E-MAX



EXECUTIVE SERIES

Standard Desk with Aluminium Profile

EX-MAX-DK200EL

L 2000 x W 900 x H 750 mm

EX-MAX-DK220EL

L 2200 x W 900 x H 750 mm



Precise, Attention to Details

Speaks for itself

MAX combines timeless classic stylistics with modern details and the highest quality manufacture. The aesthetic requirements are not inferior to ergonomic requirements, which provide comfortable usage of the furniture during everyday activities. As a result, MAX is a perfect solution for the modern manager as well as the combination of prestige and individual style with usage comfort.

E-NOBLE 2.0



EXECUTIVE SERIES

Standard Desk & Side Return (A)

EX-NBL-SDA180L/R

L 1800 x W 1800 x D1 900 x D2 500 x H 750 mm

EX-NBL-SDA200L/R

L 2000 x W 2000 x D1 900 x D2 500 x H 750 mm

EX-NBL-SDA220L/R

L 2200 x W 2000 x D1 900 x D2 500 x H 750 mm



Every Details Is Our Concern

Truly designed for executive offices

NOBLE is an interpretation of timeless simplicity. This design works for virtually many demographics anywhere.

E-VALENTI



Standard Desk & Side Return

EX-VAL-SD230L

L 1750 x W 900 x H 750 mm

EX-VAL-SD175R

L 1750 x W 900 x H 750 mm



Origin, Extraordinary

Create values for your space

VALENTI, an extraordinary origin. Valenti idea derives from our popular product 'MONTINI!'. This elegant desk was conceived to reflect the status of success. With Valenti, you will have the flexibility that you always wanted.



Standard Desk & Side Return

EX-VAL-SD230L

L 1750 x W 900 x H 750 mm

EX-VAL-SD230L / R

L 1750 x W 900 x H 750 mm

The impact is far-reaching

Valenti's luxurious look formed by 2 layers of contrasting table tops which make it unique and strong. The worktop uses trendy MFC with a leather insert to create a high visual impact executive desk

Well Organized, Well Prepared

It provides security to confidential documents with both mobile and fixed pedestals. They makes a personal working areas more organized. Finished in same wood grain of the of the top and sides, makes it a complete luxurious look to Valenti collection. MFC





4
SYSTEM SERIES

SOVICA-A



DESKING

Double Side Workstation with Fabric Screen Panel

SOV-F-CL6A-D

Length: 3600 / 4200 / 4500 / 4800 / 5400 mm

Width: 1200 / 1480 mm

Table Height: 750 mm



Elegant Slim Table

Design for offices, contract furnishing spaces and the home

The sophisticated design that distinguishes these tables makes them easy to fit into modern co-working environments as a sharing table capable of facilitating teamwork.



Double Side Workstation with Fabric Screen Panel

SOV-F-CL2A-D

Length: 1200 / 1400 / 1500 / 1600 / 1800 mm

Width: 1200 / 1480 mm

Height: 750 mm

Teamwork Tables

Bench stations are designed to encourage teamwork and direct confrontation between colleagues. The modularity allows to create various compositions for the table top and screen panel, optimizing the use of the available space.

The Essence of Lightness

Stylish workstations, for operating and functional stations. Complete the practical spaces where every object find its own place.



**Double Side Workstation For 4 Person
(with Acrylic Screen Panel)**

SOV-F-CL2A-D

Length: 2400 / 2800 / 3000 / 3200 / 3600 mm
Width: 1200 mm
Height: 750 mm



Single Side Workstation for 2 Person

SOV-F-CL2A-S120-70

Width: 2400/2800/3000/3200/3600 mm
Depth: 700 mm
Height: 750 mm

SOVICA-N



DESKING

Double Side Workstation - WTB for 4 Person

SOV-F-CL4N-D120C

Length: 2400 / 2800 / 3000 / 3200 / 3600 mm

Width: 1200 mm

Height: 750 mm



Meet the Demands

Culture at work

In many workplaces we talk about organizational culture, which defines the qualities of a work environment. It is a powerful element that shapes the workplace, the way we work, interpersonal relations and organizational processes.

Dynamic Work

The modularity of the Sovica-N collection bench makes the collection adaptable to any type of environment, making the best use of space and promoting collaboration.



Double Side Workstation for 4 Person

SOV-G-CL4N-D120-120

Length: 2400 / 2800 / 3000 / 3200 / 3600 mm

Width: 1200 mm

Height: 750 mm



Double Side Workstation with Fabric Screen Panel

SOV-F-CL4N-D120-120

Length: 2400 / 2800 / 3000 / 3200 / 3600 mm

Width: 1200 / 1480 mm

Height: 750 mm

Functional choices

Screen dividers in melamine or covered in fabric or glass and a choice of accessories personalize the workstations, making them functional and welcoming, stimulating people to do their work.



Double Side Workstation with Aluminium Frame Screen Panel

SOV-F-CL6N-D

Length: 3600 / 4200 / 4500 / 4800 / 5400mm

Width: 1200 / 1480 mm

Height: 750 mm

SOVICA-0



DESKING

**Single Side Workstation - WTB for 3 Person
(with Fabric Screen Panel)**

SOV-F-CL30-S120-80

Width: 3600 / 4200 / 4500 / 4800 / 5400 mm

Depth: 800 mm

Height: 750 mm



Simple or Shaped

The art of organizing spaces

The minimalist design of the O leg desk is an ideal proposition for an employee desk for home, open space, and shared offices. The desk comes in two different variants - simple or shaped.

Maximum Legroom

Sovica 0 desk gives you almost unlimited possibilities to arrange your workplace. Classic design, ergonomics and functionality will allow you to derive pure pleasure from work.



Unlimited possibilities

A functional add-on in the form of an acoustic screen, which is available in various sizes and colours, will improve the acoustics in the office but also create a private space for the user.



Double Side Workstation For 2 Person

SOV-F-CL20-D120A

Length: 1200 / 1400 / 1500 / 1600 / 1800 mm

Width: 1200 mm

Height: 750 mm



Double Side Workstation for 4 Persons (with Acrylic Screen Panel)

SOV-F-CL40-D120A

Length: 1200 / 1400 / 1500 / 1600 / 1800 mm

Width: 1200 mm

Height: 750 mm

CORIUM



1 **Double Side Workstation for 6 Persons
(with Acrylic Screen Panel)**

CRM-A-CL6-D120T

Length: 3600 / 4500 / 4800 / 5400 mm

Width: 1200 mm

Height: 750 mm

2 **Standard Desk**

CRM-A-SDM-120-70

Length: 1200 / 1500 / 1600 / 1800 mm

Width: 1200 mm

Height: 750 mm



3

Quarter Joint

CRM-QJ7070

Length: 750 mm

Width: 750 mm

Height: 25 mm

Italian Design

Elegant in look, comfort in functionality

Our Corium range shares a technical and artistic concept with architecture. The organic shapes of its sturdy structure, made entirely of steel, give the range its unique avant-garde and contemporary feel.



Uniquely Structured

High values in aesthetic

Corium frame structure uniquely engineered Italian design comes in chrome finishes.



Double Side Workstation with Fabric Screen Panel

SOV-F-CL2A-D120A

Width: 1200 / 1400 / 1500 / 1600 / 1800 mm

Depth: 1200 mm

Height: 750 mm

Elegant in look, comfort in functionality

Our Corium range shares a technical and artistic concept with architecture. The organic shapes of its sturdy structure, made entirely of steel, give the range its unique avant-garde and contemporary feel.

MENTE



MODULAR

1 Standard Desk

MTE2-SDxxx-75

Length: 1400 / 1500 / 1600 / 1800 mm

Width: 750 mm

Height: 750 mm

2 Screen Panel

MTE-SCR-Bxxx-40C

Length: 600 / 750 / 1200 / 1300 /
1400 / 1 600 mm

Width: 400 mm

Thick: 18 mm

3 Hanging Sliding Door Cabinet

MTE-HSLD150-40

Size : L 1504 x W 400 x H 400 mm

4 Side Open Shelf- Upper Unit

MTE-SOS45-75-42U

Size : L 450 x W 750 x H 425 mm



Mente Workstation

Creative Workplaces

Done uniquely, minimal

Classical Simplicity - MENTE uniquely integrates minimal aesthetic design that combine maximum utilization of spaces and functionality that effectively creates an efficient work-environment for executives.

5 Mente Cabinet with MFC Door

S-HD90-196T + S-HDDP90-120T

Size: L 900 x W 450 x H 1960 mm

Size: L 0 x W 446 x H 1206 mm

6 Mente Cabinet and Glass Door with Aluminium Frame

S-HD90-196T + S-HDGA90-120T

Size: L 900 x W 450 x H 1960 mm

Size: L 0 x W 446 x H 1206 mm



Mente L Shape Workstation

2 Screen Panel

MTE-SCR-A140-40C

Length: 1200 / 1300 / 1400 / 1600 mm

Width: 600 mm

Height: 750 mm

Space Divider

Make a space feels bigger

Individuality combines perfectly with collaboration. Mente desk can be fitted with screens between the different workstations using sound-absorbing dividers. In this way, personal work does not interfere with the activity being carried out by the rest of the team and, at the same time, everyone has a shared space that fosters conversation and creativity.

Modest In Modern-day

Head up, be big



Mente L Shape Workstation

1 L Shape Desk

MTE-LD1616-75L/R

Size: L 1600 x W 600 x H 750 mm

2 Screen Panel

MTE-SCR-B160-40C

Size: L 600 x W 400 x H 18 mm

FLEX

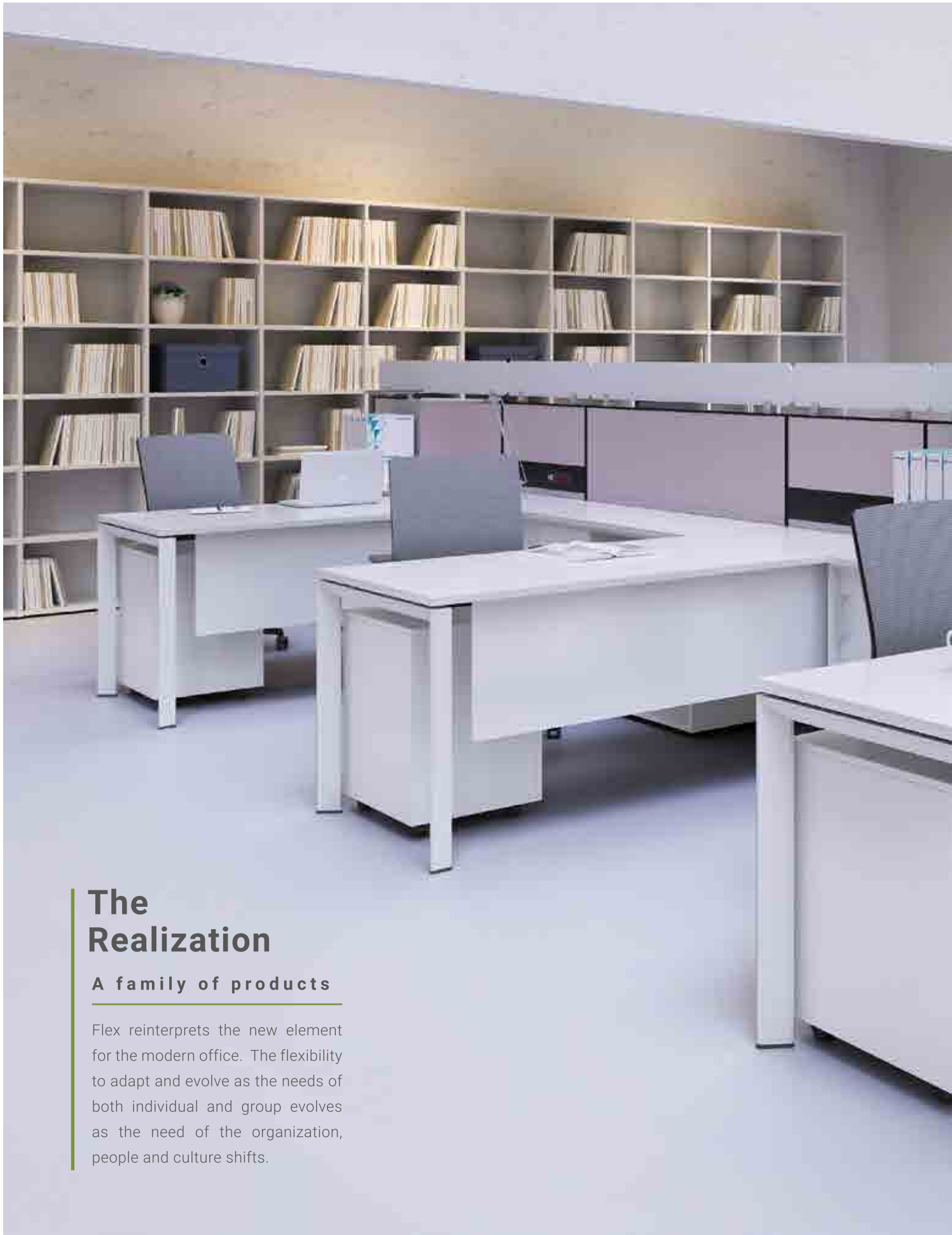

The Realization

A family of products

Flex reinterprets the new element for the modern office. The flexibility to adapt and evolve as the needs of both individual and group evolves as the need of the organization, people and culture shifts.



Flex Workstation



Traditional But In A Modern Mood

Dynamic frames to change

Flex creates micro-architectures for individual operative spaces.



Accessories that are ready to use

Plenty of possibilities for the daily approach of tasks and movements taking place at work

FONTE II



PANEL SERIES



European Design

Own the space, create yours

Fonte II came about from bringing balance and functionality together. A range of work tables with proportionate and straight lines that evolves with each project and each team. Elegant and contemporary, Fonte II responds to the changing needs of work spaces. The perfect solution for every space.



Experience our best materials

The mix materials from full glass to fabrics are possible for these panel tiles. The hollow spaces in the panels accommodates electrical cables.

Configure Endlessly

Every possibility is possible

Another modular system which creates and configures spaces with different heights and enables endless design possibilities to adapt workspaces to every need.



EVO



HEIGHT ADJUSTABLE



Healthy Movements

Sit-stand easily & flexibility

EVO height adjustable desks enables user to sit-stand easily and encourage healthy movements through out the all-day long work. The desk frames also incorporate a feature to allow quick maintenance without having to remove the table top, which makes maintaining effortless and efficient.



Functional yet Aesthetic

Dual-motor system

Functional but also aesthetic, EVO high adjustable fit for any office or home surrounding perfectly. The dual-motor system enables a faster and more stable adjustment.



Features, Enhanced Productivity

Three programmable memory presets and sit/stand reminder system with enhanced anti collision feature.

Frame Color:



Black



Grey



White

REVOSTAND



HEIGHT ADJUSTABLE



REVOSTAND Height Adjustable

ET-261H

Length: 1200 ~ 1800 mm

Width: 600 / 800 mm

Height: 690 - 1180 mm

Creative Workplaces

Done uniquely, flexibility

REVOSTAND sit-stand desks are designed to provide users with sit-stand flexibility. Our height adjustable desk enables a user to effortlessly sit or stand, encouraging healthy movements throughout the day.



Open-Architecture

Easy adjustable, access

The open-architecture design offers optimum knee and easy access below the surface. With a clean, universal aesthetic, the height adjustable desk is easily incorporated into any office or home environment.



2-person Workspace

Collaborative & multitask

Frame Color:



Black



Grey



White



HEIGHT ADJUSTABLE



MEETING & CONFERENCE

YES

METAL BASED



Conference Table with Aluminium Bar

EX-YES-RCCT-400C

Length: 4000 / 4600 mm

Width: 1500 mm

Height: 750 mm

Multi Materials

For the glass lovers

The final result is a sophisticated and contemporary office solution with it's black painted glass top. With multiple pairing options between the work surfaces, the metal structures and multi-materials used in this solution provides that exclusive overall look.





Meeting Table

EX-YES-RCMT-180/200

Length: 1800 / 2000 / 2400 mm

Width: 900 / 1000 / 1100 mm

Height: 750 mm

Hide well with smart hidden beam

The multi materials desk has a unique "Y" shape chrome metal structure legs that can epitomizes hidden wire management from the ground stages.



Conference Table with Aluminium Bar

EX-YES-RCCT-300C

Length: 3000 / 3600 mm

Width: 1500 mm

Height: 750 mm

Neat, tidy and organized

Large scale conference table brings artisan focus in the boardrooms. Passages of hidden storages below can also be covered with matching finishing that keeps the desk looking tidy and organized.

SOVICA-A



**Conference Table with Wooden Trap Door
Double Brush**

SOV-F-CT2A-xxx-148

Length: 3000 / 3600 / 4000 mm

Width: 1480 mm

Height: 750 mm

Contrast Finishes

Striking in their design

Sovica range offers a great variety of choice as well as meeting tables. The design for Sovica is to provide good relation between personnel and the organization with appropriate methods of office uniformity.



SOVICA-N



Conference Table with Wooden Trap Door
Double Brush

SOV-F-CT2N-xxx-148

Length: 3000 / 3600 / 4000 mm

Width: 1480 mm

Height: 750 mm



The Right Atmosphere!

No Matter How Many Are Present

Sovica furniture collection with a unique design made of high quality raw materials. The lightness of its look contrasts with the solidity of the thick steel structure. The design offers overall office solutions thanks to the versatility and possibilities.

SALSA



Training Table with Modesty Panel
and Connector

SAL-FDxxx-060E

Length: 1400 / 1600 / 1800 mm

Width: 600 mm

Height: 730 mm



Adaptable, Flexible

**Just remember where
you started**

Our Salsa tables are functional for training and studying. They fit the bill wherever flexible work surfaces are needed. For collaboration space needs, tables can be fixed, or equipped with castors, classroom or training center can be reconfigured or appear and disappear effortlessly.

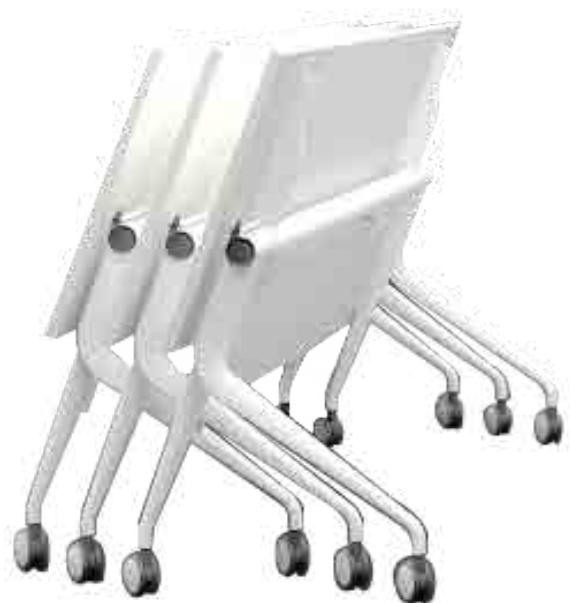

To assemble, disassemble and store

This flip top version enables assembling, disassembling and storing of desk to optimize the space. The Salsa metal legs are epoxy white powder coated with castor rollers fixed so that it can seamlessly integrate to create a complete environment.

Connect and Disconnect

Salsa offers the possibilities to connect and disconnect in a quick and simple way using a simple connector kit that secures the positions. No tools are required to remove the modesty panel or engage the ganging mechanisms. All you need to do is to release the lever and the work top flips back to its nesting position.



ORO



PANEL BASED



**Conference Table with
Aluminium Cable Box**

ORO-PCT-390

Size : L 3900 x W 1500 x H 750 mm

Refined, Balance

**Everyday, 83 million people
attend 11.5 million meetings**

The conference room is one of the visiting cards of the company. The prestigious lines in this ORO table impresses at first glance. The power, network and laptop cables disappear into the cable tray. The superb materials and solid legs speak a very clear language of confidence throughout the meeting's agenda.



Meeting with the Top!

Speak with confidence in the meeting, with this meeting table in your boardroom. This meeting tables will always gives extra helps and support by its tough leg and solid feature.

Technology connections made easy

Timeless in design. The leg space for this meeting table can be shield with panels, netboxes countersunk flush with the table tops and concealed power and data management.



PERFORM



PANEL BASED

Conference Table with Aluminium Cable Box

PFM-PCT-390

Size : L 3900 x W 1500 x H 750 mm



Durability, Stability

Making an impression is on the agenda

The reassurance of the heavy solid frame in black determines the stability and energy of the gathering crowd at the table. Craftsmanship comes into play with the materials in this version from having an upholstered leather coverings at the edge profiles thus providing long hours of comfort at the elbows levels adding to its ergonomic features.

H6 RECEPTION





Identity, Long-lasting

Exclusive by invitation

Simple yet contemporary look, AVA reflects the flexible personality and modern image of the company. Ava reception desk is specifically designed to be stylish, long lasting and flexible which ensures guests always feel welcome

Reception Counter

AVA-RCCH110-180

L 1800 x W 725 x H 1100 mm



Reception Counter

AVA-RCCH110-200

L 2000 x W 725 x H 1100 mm

Counter Head (for AVA reception)

1340L x 300W x 620H mm



Warm welcome

AVA recognizes the importance of keeping the point of entrance to any working environment as impressive as possible. It offers extensive features that suit different design of reception area ranging from table surface with variety of materials, colors, and sizes, strong metal structures, cable management and unique hutch that keep working spaces neat and tidy.

FRONTIS



RECEPTION



Frontis: Front Facade

with Style Forward

The reception has a key role because it represents the interface between the outside world and the company by representing the same image, it can be defined as the business card of the brand it represents.

The high top and frontal panels of Frontis are made of coupled stoneware with glass.



W a r m w e l c o m e

The use of light emphasize the dynamic lines of the Frontis Reception





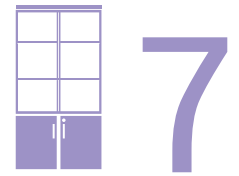

FILING & STORAGE

NORMA



1 Sliding Door Cabinet

S-SLD90-75T

Size : L 900 x W 450 x H 750 mm

2 Lateral File Cabinet

S-LF90-72T

Size : L 900 x W 450 x H 725 mm

Credenza

3 Swing Door & Lateral File Cabinet

S-OS90-72 + S-DP90-72 + S-LF90-72

Size : L 900 x W 450 x H 725 mm

4 Swing Door & Open Shelf Cabinet

S-OS90-72 + S-DP90-72 + S-OS90-72T

Size : L 900 x W 450 x H 725 mm

File Cabinet

5 4 Doors Cabinet

S-HD90-196T + S-HDDP90-120T

Size: L 900 x W 450 x H 1960 mm
Size: L 0 x W 446 x H 1206 mm

6 Glass Door Cabinet

S-OS90-177T + S-GDA90-177T

Size: L 900 x W 450 x H 1770 mm
Size: L 0 x W 446 x H 1715 mm



Valuable, Variety

Everything seems right

NORMA, not only can adapt to your budget and space, it also complement the way you want your storages to work. Norma offers an excellent storage solutions for easy document archiving. A wide range of selection from Norma collection available for you to choose base on your needs.

7 Swing Cabinet with 2 Doors

S-OS90-157T + S-DP90-157T

Size: L 900 x W 450 x H 1570 mm

Size: L 0 x W 446 x W 1515 mm

PREMIO



FILING & STORAGE



Side Cabinet

Compact, Class

No regret, only satisfaction

PREMIO still remain as an important storage place in compact offices, group and team offices. A must have furniture near the workplace or as a mobile for organization of personal storages. It is so versatile and comes in different design and spaces.



Premio Cabinet with Glass Door



Do it your way

Premio can composite into most of our systems series and projects the look that you want in your office.

EPIC



**Versatile to Complement
Any Room Decor,**
from minimalist to classic



Keep Organized

Ample storage space with multiple shelves and compartments for all your collection and media essentials. The EPIC media storage cabinet is the ideal solution for those who demand both elegance and practicality in their spaces. It not only keeps your media neatly organized but also elevates the overall ambience of your living area.

DISPENSA



FILING & STORAGE

Optimize Every Inch in Your Office Area

DISPENSA is more than just a coffee station; Enhance your office space with space efficiency to deliver maximum functionality within minimal space in an office. Whether your office is a sprawling tech hub or a cozy creative studio, DISPENSA fits seamlessly with other furniture.

WE-SPACE



WE-SPACE Modularity



The Perfect Ambience for Collaborations

This sleek and innovative piece of office furniture combines style and functionality to create an unparalleled meeting experience. Say goodbye to cable clutter, keeping your meeting space tidy and neat. Adapt the table to your specific needs, enveloping with premium acoustic materials for a sanctuary place for discussion and meetings away from distractions. Crafted with precision, WESPACE will be marked by efficient technology, superior audio quality during meetings in an acoustic room and the perfect ambience for collaboration.

LOCKER 2.0



FILING & STORAGE



Revolve, Collaborative, Co-working

Your belongings, in your box

As workspaces revolve to task orientated rather than fixed work spaces, Locker was designed with flexibility in mind for people to move through different parts of the office, using whichever suits the project at hand.

CUBO



FILING & STORAGE



Variable, Minimal

Never be afraid to change

Designed with high flexibility in mind, CUBO bookshelf is a chameleon in adapting in many needs for space and storages at home or in the office.



More compartments more spaces

Designed with high flexibility in mind, CUBO bookshelf is a chameleon in adapting in many needs for space and storages at home or in the office.



Coordinate well, means alot

CUBO allows you to organize documents efficiently and help locate them quickly. CUBO specifically helps to create a homely and relaxed atmosphere with its design.

MURO



Modular Storages

Muro allows you **TO CREATE** your own composition like building blocks, side by side or on top of each other

1 **Muro Cabinet**

MRO-4L16040

Size : L 1600 x W 400 x H 1600mm

2 **Muro Cabinet**

MRO-3L20040

Size: L 2400 x W 400 x H 1332 mm

3 **Muro Cabinet**

MRO-2L20040

Size : L 3200 x W 400 x H 905mm

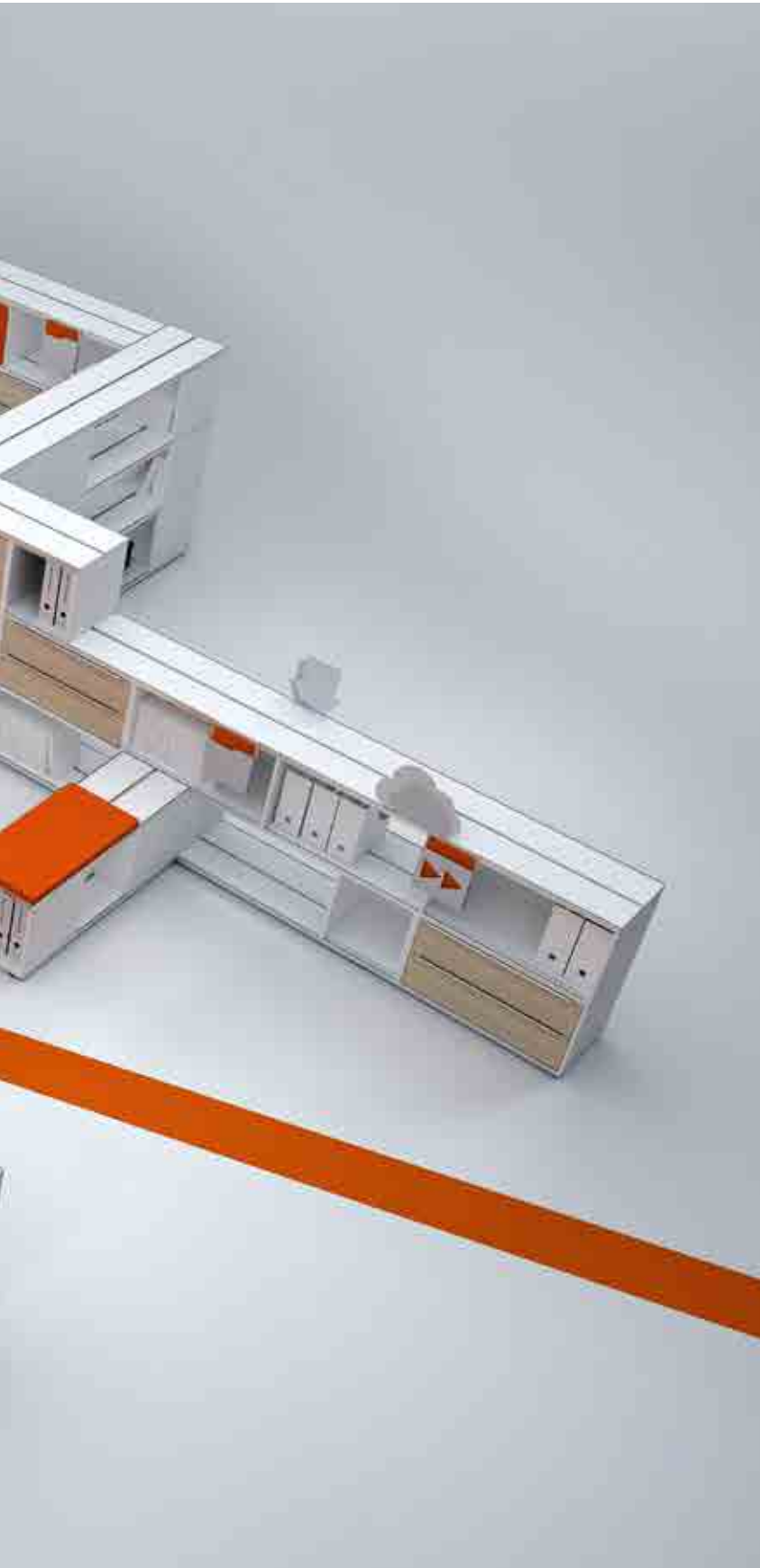

Conceptual, modern

Modular with interactive. Its fun!

The Muro concept is a fun element that we played around. Muro breaks away from the old traditional boxy storage into an interactive, modular and open plan viewing across the workplace



Muro Cabinet

MRO-4S480132

Size : L x W 400 x H 1600mm

Integrate with optimal arrangement

The heart of MURO consists of a skillful combination of totally modular storage structures. These units can be arranged in vertical layers which double up as space divider, and are designed for optimal integration with the desking system.



Usability, Enjoyment

Sizes? Its fit all, absorbs all

MURO can adapt to any requirements, from small environments to large open spaces – integrating into an office with the convenience of a complete cabinet system with modern and minimalist aesthetic.



BOOKSHELF



Be Creative, Decorate & Organize

Display anywhere as you prefer

An open solution is perfect to keep your books and photos on display or to decorate with houseplants. You can display or make them a true highlight of your interior design. Can stand on their own at any of your preferable place, home or office!



Reading & Relax Corner

Bookshelf as one of decorative item for home or office design in organizing books or files. It is so much more than just a place to store one's books.



Bookshelf

VCM-BS-3x3

Size : L 1190 x W 295 x H 1190mm

Bookshelf

VCM-BS-3x2

Size: L 802 x W 295 x H 1190 mm

Bookshelf

VCM-BS-2x3

Size : L 1190 x W 295 x H 810 mm

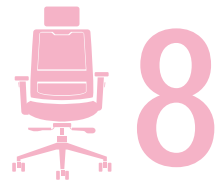

SEATING

TASK & WORK



NUV-D00251-H



NUV-D00251-M



NUVO

Simple & Modern

The 2 classic colors of black and grey could fit both home and office environments. The high elastic mesh fits your body in various position that **provide you extreme comfort.**



PX-8410N-24D91-B



PX-8411N-24D91-G



PX-8413N-89EA-G

PIXEL

Design at Its Best

Pixel redefines office seating as it conveys a sense of ease, value and comfort. The chair's design and handling are equally ingenious. You can confidently tick all the boxes in terms of function and design, as Pixel is simply a seamless solution for all workspace.





LUC-226-H



LUCENT

Physical Adaptability

The Lucent were designed to encourage users to change their physical posture and adapt dynamically to every movement. Both the moulded seat and the back follows the movements of the seated person and the correct angle by stopping in multiple locking system that enables height adjustment and tension adjustment.



VS3023E-H



VS3023E-M

JIFFY

Simple Yet Durable

Equipped as standard with seat height and seat depth adjustment. Height-adjustable 3D armrests with adjustable height, width and depth. The backrest extends downwards to conceal mechanical elements, with 1 line in aluminium line to add the beauty of the chair.





CUE-CH-817D



FLOW

Colour are Vivid

Present the chair to go with the FLOW and make the space full of vitality.



VE2015-H



VE2015-M



VE2015-V

JEST Ergonomic Highback

JEST is designed with combination of multiple locking system enable height adjustment. Allow users to move it up and down to get the most **comfortable for the lumbar support.**





ASR-CH-6230A-HS



ASR-CH-6230B-HS



ASTRAL

Embracing Nature's Leaf-Shaped Elements

Discover the captivating integration of leaf-shaped elements into our innovative design. By abstractly incorporating bud-inspired elements, we have infused vitality into the office environment, making it more lively and inviting. These leaf-shaped elements effectively support the users' backs, ensuring comfort and ergonomic well-being.



PRT-CH-6235A-HS



PRT-CH-6235B

PRESTIGE

Unleash Comfort & Space

Immerse yourself in the perfect blend of sitting and space exploration. Our chair boasts a mesh material that effortlessly conforms to your body contours, providing a natural and ergonomic fit. By intelligently distributing the weight of your back and thighs to the seat and backrest, we minimize the discomfort caused by pressure points, ensuring a truly enjoyable seating experience.





XC 51115



XC 53115



XC 51215



PREMIUM SEATING

X-CODE

Sophisticated Dynamics

The striking backrest is made up of a sturdy plastic shell with a flexible tensioned membrane. The soft, multidimensional backrest fabric ensures optimum climatic conditions and support for the entire back thus, the breathable material complements the overall sophisticated look.



LO 3027



LO 3010



LO 3315 PU

PREMIUM SEATING

LORDO FLEX

Modern in Look.

Reflecting a modern aesthetic, Lordo flex features an elastic mesh fabric mounted on a height adjustable backrest which pivots at the lumbar region, allowing the backrest to "flex" with the user's movements.





TASK & WORK

PREMIUM SEATING

FREEDOM

Effortless Recline

Freedom's intelligent recline mechanism automatically provides custom support for every user, and encourages healthy, spontaneous movement throughout the day. Without cumbersome knobs or levers, and with no manual adjustments, Freedom task **makes active sitting effortless.**



PREMIUM SEATING

LIBERTY

Encourages Movement

Liberty was engineered to automatically adjust to whoever sits in it, instantly accommodating each user regardless of size and weight. Because it has no manual adjustments and features Humanscale's weight-sensitive recline, the user **can move easily and without restrictions.**



EXECUTIVE



VE2003-H



VE2003-M



VE2003-VA



ZEE

Ergonomic Leather

Thick padded foam covering with polyurethane leather in the Zee executive chair. The combination of this material provide good support especially on your lower body for **long hour seating for an ergonomic seating position.**



VKM053-H



VKM053-L

ZEST

Graceful Lines

Simple yet modern, the chair is designed for maximum comfort that fully supports the human back. The graceful lines will beautify the working environment. Zest will be your ideal choice if you want to **furnish your office with trendy furniture.**





VKM733-H



VKM733-L



VKM733-VA



STYLE

Integrated Style

Executive seating Style's backrest is intergrated with the seat. The leather wrap around the thin padding with fine details to give the character to this chair. Chrome structure with black leather imbues a high-quality look and feel yet **provide comfort for long hour seating.**



LX-6210F-16D91



LX-6212F-16D91

LEXICON

An Unending Choice

No matter what style of office design you select, your piece can be upholstered in an unending choice of fabrics in all colours with kicky textures and patterns. Take your working space from bland to bold with a hearty serving of colour inspired by our favorite **colourful fabric designs.**





VP1012-H



VP1012-L



ZEN

Elegant & Refined

The Zen is an elegant and refined seating series created by the Versalink. Clean simple lines make the Zen the **perfect choice for meeting rooms, boardrooms and private offices.**



VP1011-H



VP1011-M

ZING

Graceful & Comfort

Simple yet modern, the chair is designed for maximum comfort that fully supports the human back. The graceful lines will beautify the working environment.





AME-A1701



AME-B1701



AME-C1701



AMELIOR Color World

The unique material combination, pure and fresh color matching, everything is the revealing of clever mind and **show infinite modern æsthetic feeling.**



MOD-A1726-1



MOD-B1726-1



MOD-C1726-1

MODESTO On Brand

Away from the complex visual, between one table and one chair, it achieves the soul of the office, borrow a bit of tranquility from the plain color. Difference between them is **very simple, low profile and high profile!**





SUP-CH-6240A



SUP-CH-6240B



SUP-CH-6240C



SUPREME

Unleash Freshness & Productivity

Enhance your workspace with our executive chair designed to elevate your experience. With its tall backrest and ergonomic body contour, it provides unbeatable support to your entire back, shoulders, and neck. Stay fresh and maintain peak productivity even during long hours of work.



ETE-CH-90066A



ETE-CH-90066B

ELITE

A Symbol of Prestige & Pride

Experience the elegance of our split design seat back, exuding a sense of simplicity and refinement. The PU surface armrest adds a touch of contemporary style, perfectly capturing the essence of the modern era. With a larger tilt angle, our seats provide ultimate comfort for long hours of sitting.





PREMIUM SEATING

DUCARE

Adapts Perfectly

Noticeably more comfort when sitting. The lockable Synchronits® constant counterpressure, it also provides useful support for the ideal posture when sitting. Thanks to its safety height lift, its **adapts perfectly** to any body size.



PREMIUM SEATING

SIGNO BLACK

The Shape Follows the Back

Design is the language and comfort its signature. Both are closely linked to anatomical precision. The upholstered swivel and cantilever chairs leave nothing to chance. They provide good vibrations. **Easy on your back and with a powerful presence.**



TRAINING, VISITOR & CONFERENCE



MTK-CH-128A



MTK-CH-128B
(with Roller Wheels)



MTK-CH-128C
(with Writing Table)



MTK-CH-128D
(with Writing Table
& Roller Wheels)



MULTITASKER

Promotes Efficiency

This versatile chair features a foldable table integrated into its design, allowing users to perform various tasks efficiently. With its combination of functionality and practicality, the Multitasker Chair is an ideal choice for individuals seeking a versatile seating solution that accommodates various tasks.



CES-4RB-1210-P02



CES-4ZD - Trolley

CRESCENT

Spacious and Comfort

The seat, frame and backrest are proportionally balanced to encourage relaxed seating, even on longer period of time. The crescent seating is **suitable for activity based working models**, such as touch down spaces.





PLU-CH-L01S



PLU-CH-L01ST
(with Table)

PLUSH Leisure Chair

The upholstered cushioning provides the plushiest feel for the sitter. You'll feel comfort and so relax during long hour seminar or workshop! This chair can be place in auditorium, theatre hall or any special room in office.



SELLA SIT STOOL
CUE-HBS-02

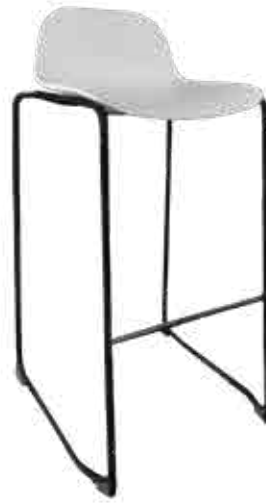

ZOLLO HIGH CHAIR
LOB-HBS-02 (750H)

SELLA & ZOLLO

Light and Practical

This seat is mobile and flexible with a clear design.
Can easily place to suit any of your workplace or small
room.



OCCASIONAL



SWITCH Space Shell

Inspired by the texture of shell, designer reflects this feeling of texture on SWITCH series with the technique of embossing, which touches smooth and stereo.

SWI-CH-02-VA



PREMIUM SEATING

PERILLO

The Modern Art of Sitting

The shape is so sculptural that when you first encounter it you may ask yourself whether you can actually sit on it. But Perillo is not just designed to look good. It is also a comfortable chair which feels great to sit on thanks to the finest materials (walnut, oak, leather). Its seat surface, backrest, armrests and sub-frame come together to produce a **stylish piece of seated furniture**.



STOOL



SWITCH

Fit Everywhere, Anywhere

Switch series is composed of stools with two options metal base or which can meet different areas and environment. What's more, **different bases can perfectly fit wherever you want.**



TUNE

Minimalist Modern

Tune series tangential design is not only for the appearance but also provides a greater foot space from the bottom inside of the tangential angle, to meet the user's needs of different sitting postures and ergonomics, the upper and lower color separation design makes the product more colorful, **to satisfy different space and different user.**



LOUNGE

CRAFT

Business Sofa

LOUNGE



CRAFT
Lounge

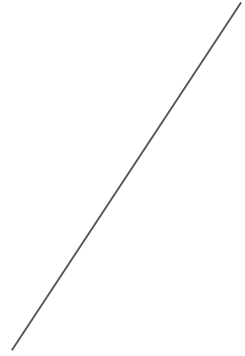

Fit Everywhere, Anywhere

Comfort Upholstered

Craft Lounge Sofa comes in leather upholstered which can meet different areas and environment. What's more, choose your preferred sofa to suit your lounge or room.



Single Seater Sofa

LG-CFT-3SSQ5C3-1

L 1060 × W 950 × H 780 mm



3 Seater Sofa

LG-CFT-3SSQ5C3-3

L 1060 × W 950 × H 780 mm



3 Seater Sofa

LG-CFT-3SSD9EHE3
L 2060 x W 950 x H 780mm



Single Seater Sofa

LG-CFT-SSD9EHE1
L 1060 x W 950 x H 780 mm





Single Seater Sofa

LG-CFT-SSSV8D-1

L 850 x W 670 x H 680 mm



LOUNGE

Double Seater Lounge

LG-CFT-DLSV8D-2

L 1390 x W 1130 x H 700 mm



Single Seater Sofa

LG-CFT-SSSE116A1-4

L 1000 × W 860 × H 700 mm



Foot Stool

LG-CFT-FSSE116B-4

L 1215 × W 590 × H 400 mm



3 Seater Sofa

LG-CFT-3SSE116A3-4

L 2200 × W 860 × H 700 mm



LG-CFT-SSSE15EHE-1

Single Seat : L 910 x W 800 x H 790 mm
3 Seater : L 1910 x W 800 x H 790 mm



LG-CFT-SE19AHE-1

Single Seat : L 1060 x W 830 x H 820 mm
3 Seater : L 2060 x W 830 x H 860 mm



Single Seater Sofa

LG-CFT-SSSE44AHE1

L 1060 x W 870 x H 880 mm

3 Seater Sofa

LG-CFT-3SSE44AHE3

L 2020 x W 870 x H 880 mm



LG-CFT-SE19AHE-1

3 Seater Sofa : L 1880 x W 760 x H 670 mm



LG-CFT-SSSQ2C41

Single Seat : L 880 x W 760 x H 670 mm



Recliner Electric Chair

LG-CFT-RCN0011- LN

L 850 x W 850D/1500 x H 990 mm



LG-CFT-SV15E-1

Single Seat : L 1060 x W 830 x H 820 mm

3 Seater : L 2060 x W 830 x H 860 mm



Single Seater Sofa

LG-CFT-SSSE22EHE-1

L 900 x W 1000 x H 900 mm



3 Seater Sofa

LG-CFT-3SSSE22EHE-3

L 2000 x W 1000 x H 900 mm



Single Seater Sofa

LG-CFT-3SSSV13E-1

L 730 x W 860 x H 840 mm



3 Seater Sofa

LG-CFT-3SSSV13E-3

L 1730 x W 860 x H 840 mm



Single Seater Sofa

LG-CFT-SSSV8D-1

L 850 x W 670 x H 680 mm



3 Seater Sofa

LG-CFT-3SSSV8D-3

L 1850 x W 670 x H 680 mm

OASIS

Public Spaces



LOUNGE



OASIS

Public Area
Office Series





Modular Sofa Seat

LG-OAS-MS253A4

L 440 × 600 × 650 mm

Modular Sofa Seat

LG-OAS-MS254A4

L 340 × 380 × 410 mm



Shape and combined

This bright color sofa lounge combined with the shapes of back or the seat armrests serve an excellent seating experience as well. With the use of unique fabric, this sofa shows the brilliant temperament, which is born to be the bright points wherever it's served.





Bright and Practical

Place and decorate it at the lounge or any available space, this sofas add warmth and coziness to office, home or lounge area.





LOUNGE



Single Seater Sofa

LG-CFT-3SSQ5C3-1

L 1060 × W 950 × H 780 mm



Coffee Table

LG-OAS-CFSH138D
ø 400 × 500 mm



Rocking Stool

LG-OAS-RSSH131DHH
L 800 × W 430 × H 400 mm



Rocking Stool

LG-OAS-RSSH131D
L 800 × W 430 × H 400 mm



Foot Stool

LG-OAS-FSSE25D
L 450 × W 410 × H 400 mm



Cube Stool

LG-OAS-CSSH39DHH
L 400 × W 400 × H 420 mm



Cube Stool

LG-OAS-CSSH39DCH
L 400 × W 400 × H 420 mm



Foot Stool

LG-OAS-FSSH38DHE
ø 580 × 450 mm



Foot Stool

LG-OAS-FSSH38DCH
ø 460 × 450 mm



Lounge Seat (Left)

LG-OAS-LSSE41DL
L 1280 × W 830 × H 1050 mm



Modular Seat

LG-OAS-MSSE142AB4
ø 500 × 330 mm



Modular Seat

LG-OAS-MSSE142B34
L 1500 × W 550 × H 330 mm



Modular Seat

LG-OAS-MSSE142C24
L 1500 × W 1500 × H 420 mm



Lounge Seating with Backrest

LG-OAS-LSSU1C11
L 780 × W 720 × H 1060 mm



Lounge Seating with Backrest

LG-OAS-LSSU1C13
L 1780 × W 720 × H 1060 mm



Lounge Seating with Backrest

LG-OAS-LS020X4HS
L 700 × W 700 × H 750 mm



3 Seater Sofa

LG-OAS-3SSU2C3
L 1780 × W 720 × H 750 mm



Single Seater Sofa

LG-OAS-SSU2C61
L 780 × W 720 × H 750 mm



Single Seater Sofa

LG-OAS-SS221A12
L 690 × W 860 × H 800 mm

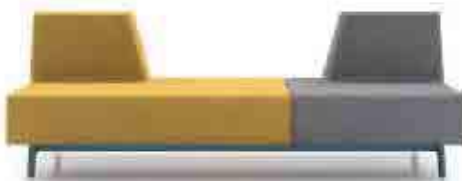

Modular Seat Double

LG-OAS-MSSE39D
L 2110 × W 800 × H 730 mm



Modular Seat Double
with side table

LG-OAS-MSSE40DR
L 1650 × W 800 × H 730 mm



Modular Seat Double with storage

LG-OAS-MSSE39DRB
L 2450 × W 800 × H 730 mm



Modular Sofa Seat

LG-OAS-MSSE25BHE2
L 1400 × W 670 × H 770 mm



Bar Table

LG-OAS-BTLA18
L 1800 × W 800 × H 950 mm



Discussion Table

LG-OAS-DTM003
Ø 900 × H 750 mm



Coffee Table

LG-OAS-CTQA12
L 1200 × W 600 × H 450 mm



Coffee Table

LG-OAS-CTQB04
L 550 × W 550 × H 450 mm



Coffee Table

LG-OAS-CT228A
Ø 1010 × H 370 mm



Coffee Table

LG-OAS-CTA08
Ø 800 × H 680 mm



Coffee Table

LG-OAS-CTB08
Ø 800 × H 680 mm



Coffee Table

LG-OAS-CTB05
Ø 510 × H 635 mm



Coffee Table

LG-OAS-CTC04
Ø 450 × H 800 mm



Coffee Table

LG-OAS-CTD04
Ø 450 × H 800 mm



Coffee Table

LG-OAS-CTE04
Ø 450 × H 800 mm



Coffee Table

LG-OAS-CTF05
Ø 500 × H 610 mm



Coffee Table

LG-OAS-CTQ12
L 1200 × W 600 × H 520 mm



Coffee Table

LG-OAS-CT08A
Ø 800 × H 520 mm



Coffee Table

LG-OAS-CT08B
L 800 × W 800 × H 520 mm



High Coffee Table

LG-OAS-HCT05
L 500 × W 430 × H 650 mm



Bar Table

LG-OAS-BTB32
L 3200 × W 820 × H 950 mm



Double Seater Lounge

LG-OAS-CT08B
L 1570 × W 790 × H 1150 mm



Lounge Seating with Backrest

LG-OAS-LS43EHE1
L 780 × W 800 × H 860 mm



Partition with Divider

LG-OAS-CTQA12
L 1500 × W 360 × H 1000 mm



Modular Sofa Seat

LG-OAS-MSSE42D
L 400 × W 580 × H 700 mm



Modular Sofa Seat

LG-OAS-MS241A4
L 810 × W 700 × H 940 mm



Modular Sofa Seat

LG-OAS-MS242A4
L 250 × W 700 × H 400 mm
LG-OAS-MS241B4
L 810 × W 700 × H 1100 mm



CONNECT

Sit and Connecting

Connect series provides different single elements to group that you can get any combination you want to fit your space perfectly. Connect seating element is invested with their function and lies there orderly. Connect series consists four parts from a sofa: seat element, armrest element, back element and pouf element, that **you can combine them as you like to fit any space if you require.**



SNUG

Sweets and Smooth

Inspired from jelly sweets, the shape of Snug is round, organic and elegant. Touched round and smooth, the shapes of back and armrests serve an excellent seating experience as well. With the use of unique fabric, Snug series shows the brilliant temperament, which is born to be the **bright points wherever it's served.**





GALORE

Variety and Colorful

A friendly set which upholstered with **variety and colorful** Scandinavian touch of fabrics, Galore design will be **never outdated**.



INSPIRE

Curved & Complement

Inspire developed what eventually became the series. Inspire is an innovative, with its personal twist. The simple lines are classically Scandinavian, while the details give the furniture a striking new expression. Despite the contrasting elements, the top and bottom **still merge into an entity that is quite unique.**





LAVISH

Smooth Designed

Designed, lightweight and simple, Lavish is a frame sofa with full of smooth lines and warm materials. Its deep seat perfectly supports the casual recline of the body.



MAZE

Give a Break, Give a Space

A multi-functional bench. Maze lounge bench is suitable for the breakout space where the co-workers take a break from the work and stimulates interaction with others. The gap between the seat be use to store magazine and give your eyes a **break from excessive bright light.**





LUKE

Serene with Versatility

The unique profile of the metal leg and the surface of leather are the combination of modern – classic look for Luke sofa & lounge. At the end of a long day, settle into a sofa in comfy leather. **These comfortable sofa will complete your space**



HAYDEN

Graceful Lines

Hayden sofa is concise. It brings comfortable feeling with design element that will occupy your office or home. The design **display the unique height** of the armrest to give support and complacement.



COFFEE TABLE





OVAL



DOUBLE



ARTETA



ORB



SUSPA



HOLLIS

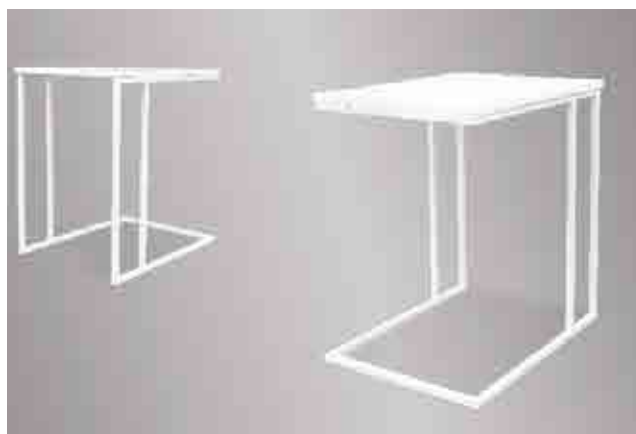

THOR

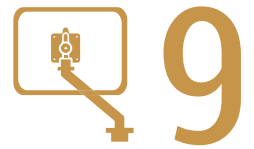

ACCESSORIES



POWER OPTION & SOCKET

The cable management system is an important range which is integrated into all its operative system is such as cable tray, trap door, sockets, power cable.

ERGONOMIC TIPS

Posture and screen position

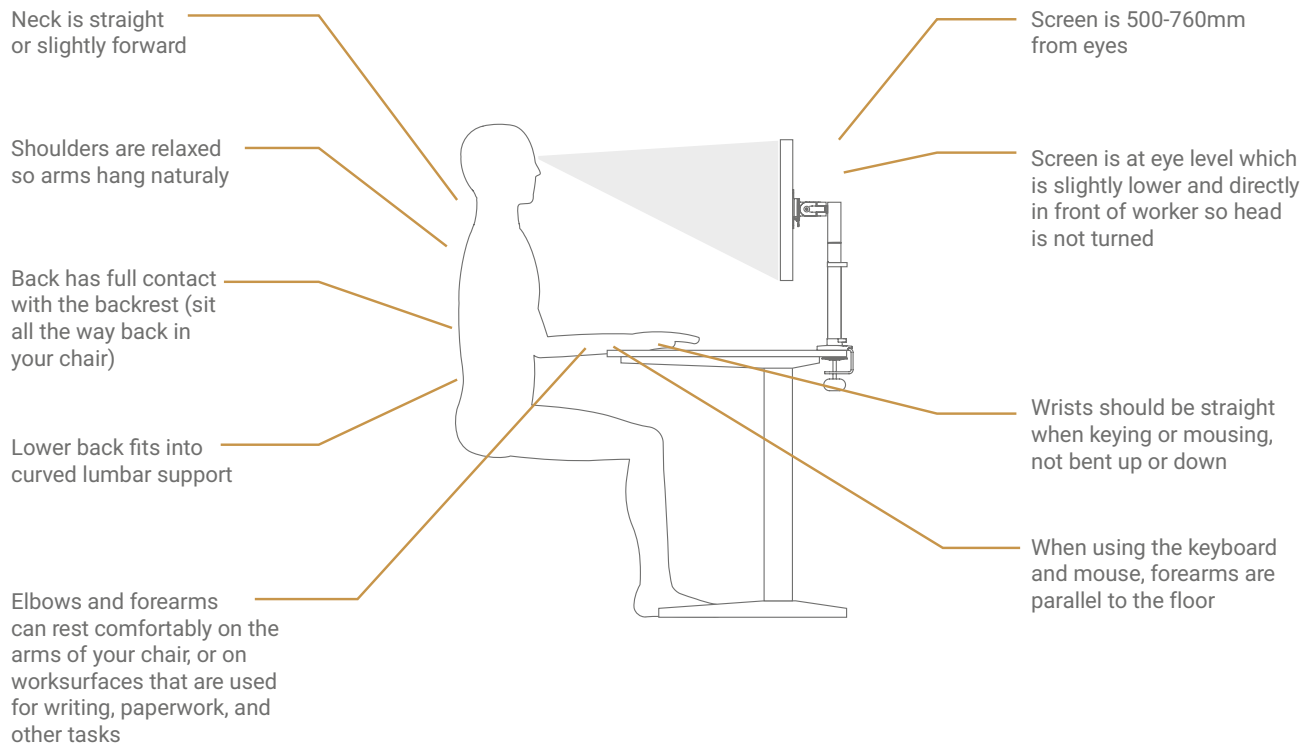

Screen position

Single screen position

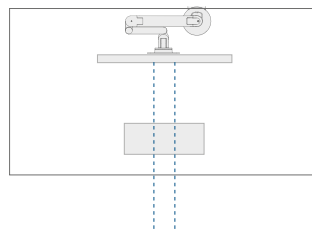

The proper position of a single monitor is straight in front of you and has a distance not more than your straight arm

Dual screen position

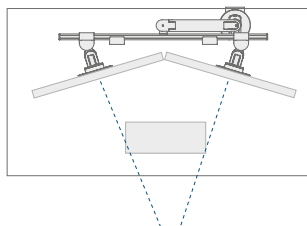

Dual screen should have a panoramic view so the distance from your eyes to the screen is the same

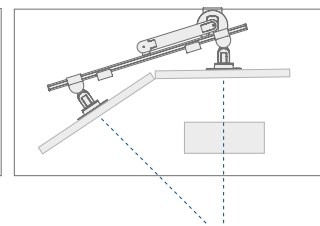

When making one screen your main screen the secondary screen should be in a panoramic view as well so your eyes have the same distance to this screen

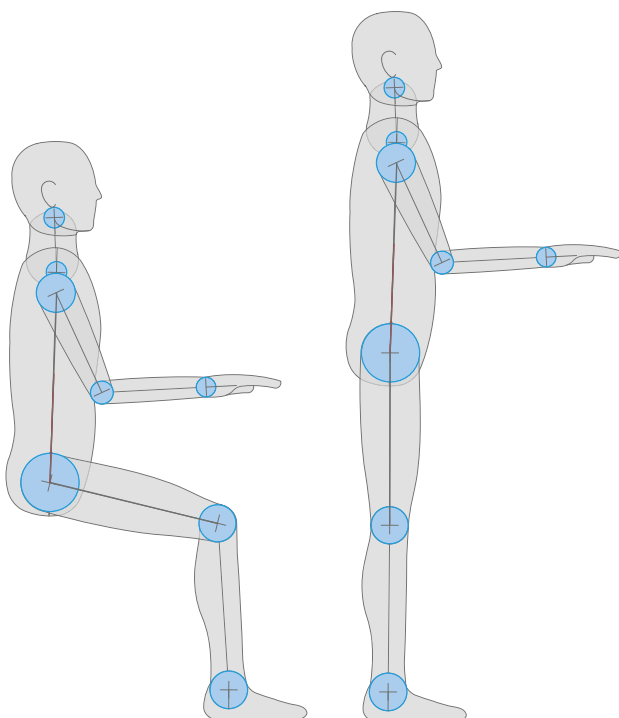



WORKTOOLS

Monitor Arm

In today's fast-paced digital world, ergonomic monitor arms and mounts enable instant personalization of the workplace for improved comfort, health and productivity. Monitor arms not only provide clutter free workspaces, they support a healthier, more ergonomic working posture.



- EGDF-202
 - EGDF-302
- W152xD522xH274~581mm



- EGDF-202D
 - EGDF-302D
- W841xD114xH101~475mm



- Clamp Mount Type
- Grommet Mount Type



- EGDF-202DB
 - EGDF-302DB
- W714xD595xH290~624mm



- Clamp Mount Type
- Grommet Mount Type



Bring Increased Flexibility

and Ingenious Ergonomics to the Workspace

Designed with impeccable flexibility and an eye-catching appearance, this monitor arm provides an ideal choice for creating a comfortable and attractive workspace. Quick-release joint ensures easy user assembly while reducing packaging size. Integrated cable clips organize the cables for a clean look.

ELEVATE-SINGLE Assisted Monitor Arm

VLL-LDT75-C012H

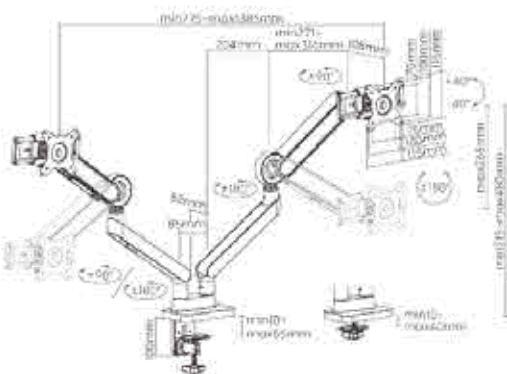

1 Clamp

2 Grommet

Features

- Dynamic Monitor Arm + Two Piece Clamp + VESA Plate,
- White
- Weight Capacity: Up to 7kg (15.5 lbs.)
- Height Adjustment Range: Up to 440 mm (17.3")
- Supports up to 34" Monitor



Bring Increased Flexibility

and Ingenious Ergonomics to the Workspace

The classy finish together with the streamlined silhouette offers a sophisticated appearance. With a brand-new arm structure, the LDT76 Series provides a wide range of motion, encouraging a healthy posture and screen share between team members.

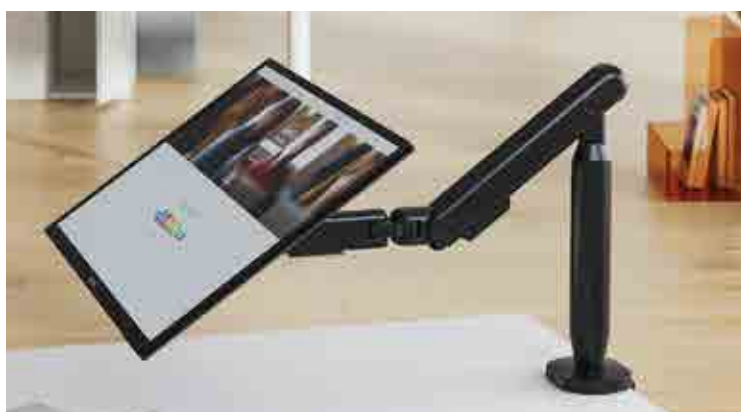

PIVOT Single Monitor Arm

VLL-LDT76-C012

Features

- Extending Arm: provides a wide range of viewing angles
- 360° Rotary VESA Plate: for more viewing experience
- Slide-in VESA Plate: for quick attachment and detachment
- Lightweight Aluminum Construction: provides a sleek, lighter, and elegant look
- Spring-Assisted Mechanism: allows to easily move up and down
- 180° Rotation Stop: prevents monitor arm from swinging into screens or walls
- Built-in Cable Management: for an organized and neat workspace

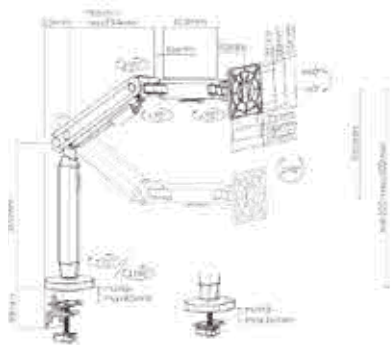



The Perfect Shape

of a Circle as the Core Structure

Simple but out of the ordinary, sleek and functional, Insertion joint assembles in minutes while reducing packaging size (perfect for e-commerce). Adjustable spring gauge enables perfect weight balance for monitors.

The cable management conceals the wires for a clutter-free appearance. When there are privacy panels or walls behind the monitor arm, the universal slider allows flexibility to put the monitors together while maintaining more spacious working space.



MASTERY SPRINT Assisted Monitor Arm

VLL-LDT75-C024S

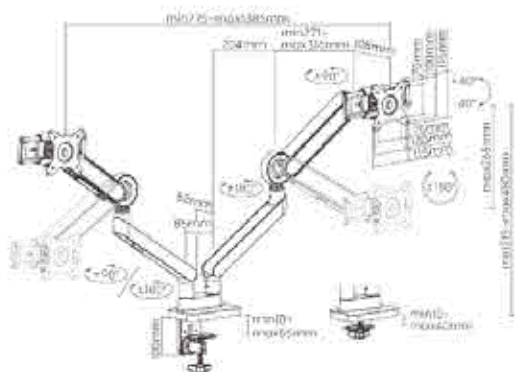

Features

- Universal Sliders: allow the monitors at a proper ergonomic distance
- Built-in Spring Tension Mechanism: for perfect weight adjustments
- 180° Rotation Stop: prevents monitor arm from swinging into screens or walls
- Easy to adjust, no tools required
- Cable Management: keeps everything organized
- Detachable VESA Plate Design: enables easy installation

Installation: Clamp, Grommet



Budget Friendly and Stylish

With an innovative gas spring X-Lift Structure comprised of flat crossmembers, the Sit-Stand Desk Converter with Keyboard Tray provides a refreshing ergonomic sit-to-stand experience for users. The two-tier design with ample weight capacity provides plenty of worksurface for daily work.



Non-Slip Pads protect desk surface and prevent movement while working.



SIT-STAND DESK CONVERTER with Keyboard Tray

VLNB-DWS34-02N

Features

- Counter-Balance Gas Spring: creates smooth and quick transitions
- Spacious Surface: for placing more devices
- Lower Keyboard Deck: holds keyboard and mouse side by side and raises in sync with the top surface creating a comfortable work space
- Smooth Edges with Rounded Corners: for added safety
- Non-skid Silicone Pads: protect work surface from scratches or scuffs
- Squeeze Handle: adjusts the height in a snap
- Quality MDF Board: features high impact resistance (TSCA Title VI compliant)
- Preset Hole: supports grommet installation (compatible with most LUMI monitor arms)
- Large Solid Base: ensures it stay sturdy and stable at any heightworkspace

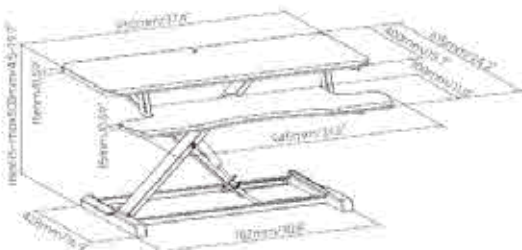



FREEDOM DUAL Monitor Arm

VLL-LDT76-C022

Features

- Screen directly mounted to arm.
- Screen Tilt
- Screen Quick release
- Portrait to Landscape rotation
- Manual Height Adjustment

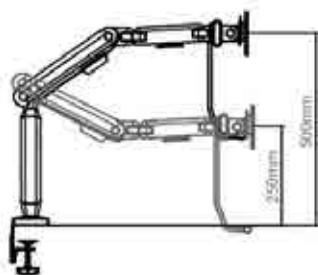



DYNAMIC DUAL Monitor Arm

VLL-TP450VP-W

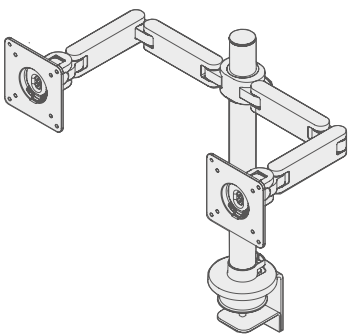

Features

- Dual Arm + Two Piece Clamp + VESA Plate,
- White
- Weight Capacity: Single or Dual Monitors
- Up to 2x 13.5 kg (2x 30lbs)
- Height Adjustment Range: Up to 375 mm (14.7")
- Supports up to 2 x 27" Monitor



ADAPTA SINGLE Monitor Arm

VLL-TP330VP-W

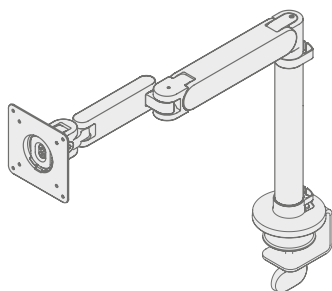

Features

- Dynamic Monitor Arm + Two Piece Clamp +
- VESA Plate
- White
- Weight Capacity: Up to 7kg (15.5 lbs.)
- Height Adjustment Range: Up to 440 mm (17.3")
- Supports up to 34" Monitor





<https://modern-emirates.com>

**MODERN EMIRATES FURNITURE
& OFFICE EQUIPMENTS
(L.L.C)**

Office Showroom

S/R # 1 Sheikh Hamdan Bldg, Al Khabaisi Road,
Deira, Dubai UAE, P.O. Box 55592

☎ +971 04 266 4445

✉ modemirt@gmail.com | modemirt@emirates.net.ae



www.versalink.com

JEMARAMAS JAYA SDN. BHD.
199101017005 (227317-M)

VERSALINK MARKETING SDN. BHD.
199101015634 (225946-K)

HQ Office, Showroom and Factory

Lot 6119, Jalan Haji Salleh, Batu 5½ Off Jalan Meru,
41050 Klang, Selangor, Malaysia.

☎ +6 03 3392 6888

✉ info@versalink.com